



Alpha Industrial Power
Spill Control Barrier System
Installation Manual

**Battery Acid Spill Control Barrier
with Acidsafe Floor Coating**

**Battery Acid Spill Control Barrier
without Acidsafe Floor Coating**

Spill Control Barrier System
Installation Manual
TABLE OF CONTENTS

| | |
|------------------------------|----|
| 1. Introduction | 1 |
| 2. Safety Precautions..... | 2 |
| 3. Initial Conditions | 4 |
| 4. Floor Preparation | 5 |
| 5. Barrier Installation..... | 7 |
| 6. Coating Application..... | 12 |
| 7. Leak Test | 14 |
| 8. Coating Maintenance..... | 15 |
| 9. MSDS Section..... | 16 |

1. Introduction

- 1.1 The Battery Acid Spill Control Barrier without floor coating is intended to contain battery electrolyte in the event of a spill or leak from a stationary lead-acid battery. The Spill Control Barrier surrounds the battery rack with a 4 inch steel enclosure. It is bonded permanently to the floor with Acidsafe Adhesive Gel and sealed against leakage. The Battery Acid Spill Control Barrier with floor coating also includes Acidsafe Floor Coating, which covers the entire floor surface within the enclosure and protects the floor from the corrosive effects of battery acid. Both the Coating and Adhesive are based on modified novolac epoxy resins with polyamine curatives and have been tested to be impervious to 70% sulfuric acid in continuous immersion and up to 98% sulfuric acid in splash and spill exposure. The system may be installed around existing battery racks without removal of the batteries and without interruption of facility operations.
- 1.2 The highly adaptable design of the system allows configuration to suit a wide range of battery room layouts. This manual covers all of the procedures necessary in most anticipated battery room applications. If a specific application is encountered that is not addressed in this manual, contact Alpha Industrial Power at 678-475-3995 for additional information of supplementary procedures
- 1.3 Neutra-Mats (part number 5NMB0010) inside the containment area absorb and neutralize the acid immediately upon exposure thus greatly reducing the risk of personal injury and structural damage or contamination. The mats are placed side by side to completely cover the floor beneath the racks. A single Neutra-Mat will fully absorb and neutralize one quart of battery electrolyte (pH between 7.0- 9.0). Each individual Neutra-Mat may be quickly and easily replaced as necessary. Additionally, Neutra-Mats turn pink upon exposure to acid, indicating a leak and the need for replacement. If Neutra-Mats were not ordered for this installation, they may be obtained from Alpha Industrial Power.
- 1.4 Despite the Spill Control Barrier and Coating's strength and durability, failure to conscientiously follow these instructions may result in inadequate coverage, performance, or protection. Carefully read and understand the entire instruction manual before beginning assembly.

2. Safety Precautions

- 2.1 Examine all shipping containers for signs of external damage. Also look for indications of coating spillage during shipment. In the event that coating material has been spilled, consult the Material Safety Data Sheet for spill handling instructions and personal protective equipment requirements.
- 2.2 Make note of any damage on the bill of lading before signing for delivery. If system components have been damaged or lost in transit, contact the shipping carrier for instructions concerning filing a claim.
- 2.3 Wear steel toed shoes and safety glasses when assembling the Spill Control Barrier.
- 2.4 Wear chemical resistant gloves and safety goggles when handling Adhesive, Coating or Joint/Crack Filler. In areas where ventilation is insufficient, a respirator may also be required. Read the Material Safety Data Sheets supplied with this kit and be familiar with the safety precautions listed therein.
- 2.5 Observe and obey all caution notes contained in the following instructions.

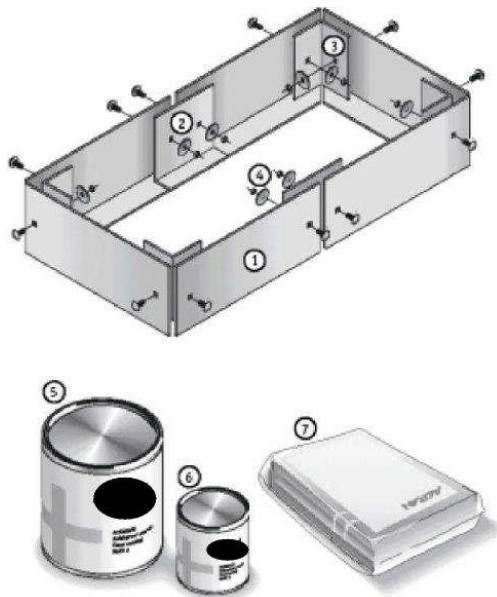

Figure 3.1 – Spill Control Barrier Components

1. Barrier Strips
2. Splice Plates
3. Corner Plate
4. Assembly Hardware
5. Acidsafe Coating (Part A) – floor coating version only
6. Acidsafe Coating (Part B) – floor coating version only
7. Acidsafe Adhesive

3. Initial Conditions

- 3.1 For maximum effectiveness of the Spill Control Barrier, the floor surface should be flat, smooth and reasonably level. An uneven surface can cause gaps between the Spill Control Barrier and the floor, which may require additional Adhesive during final assembly. Unlevel or sloped floors may require additional Coating to achieve minimum film thickness.
- 3.2 Permanent floor coverings such as vinyl, linoleum, composite or asbestos tiles will not affect the ability of the Spill Control Barrier or Acidsafe Floor Coatings to contain acid spills, provided that the coverings are in good condition and securely fastened to the floor. Loose or broken tiles should be removed and voids filled using Joint/Crack Filler Kit (part number 5CFK0001).

CAUTION:

All asbestos handling precautions should be observed when handling loose or broken asbestos tiles, including respiratory protection, protective clothing and specialized disposal. Consult with the local authority having jurisdiction for asbestos abatement requirements.

- 3.3 Concrete should be completely dry and properly cured (minimum of 28 days after poured). Concrete slabs installed on or below grade or otherwise exposed to weather may transmit water vapor, causing pinholes in the floor coating during cure. Evening (after 7 PM) is the most suitable time of day for a ground-floor installation as the effects of concrete off-gassing will be minimized.
- 3.4 Failure to properly clean and prepare the surface of the floor prior to applying the Adhesive and Coating can cause adhesion failure or degraded chemical resistance over time. Appropriate floor cleaning and other surface preparatory procedures are described in Section 4.
- 3.5 Local ambient air temperature must be greater than 50°F when applying and curing the Adhesive and Coating materials. As ambient air temperature decreases, the time necessary to set and cure the Acidsafe Adhesive and Coating increases. Cold conditions (below 50°F) will also impair the Coating's application characteristics.

- 3.6 The following tools and supplies are recommended for a quick and thorough Barrier installation:

7/16 inch box end or combination wrench

putty knife

tape measure

several sheets of sandpaper, 100 grit

roll of 1 inch masking tape

goggles, chemical resistant gloves and respirator (as needed) for

installers' paper towels or shop rags

rubbing alcohol

- 3.6.1 Additional supplies needed for Spill Barrier with floor coating version only:

small metal ruler with 1/64" increments or wet film thickness gauge.

The Coating Installation standard Tool Kit (part number 5BNK0001) contains: small rotary stirring tool, two v-notch trowels, four v-notch spreaders, one masking tape, two brushes, two gloves, two rags, two putty knives, one 3-piece extension, one 1-1/2 inch spiked pin roller, one pair goggles, and two sheets sandpaper. (Other kits available upon request)

4. Floor Preparation

- 4.1 The installer or site/equipment engineer must ensure that sufficient aisle space will remain once the Barriers have been installed. There should be a minimum of 30 inches between Barriers. Aisle spacing at the end of each rack may be as little as 24 inches, providing no conflict exists with battery maintenance requirements. The aisle spacing, including the space between the surrounding Barriers, should be sufficient to permit all required maintenance (including battery installation and removal). See the National Electric Code or contact the local authority having jurisdiction for further clarification regarding aisle clearances.
- 4.2 After clearances have been verified, locate and mark the outline of the Barrier using the Barrier's dimensions and a tape measure. The Barrier should be centered around the rack with at least 1 inch clearance in all directions to meet 1995 Uniform Fire Code article 64 requirements.

- 4.3 Completely clean and prepare the portion of flooring which will have Adhesive or Coating applied during installation. For Barrier System versions without floor coating, this area is a strip approximately 3 inches wide inside the outline of the Barrier perimeter. For Barrier System versions with floor coating, this includes the entire area inside the outline of the Barrier perimeter. Prepare the flooring according to the following guidelines.

All Floor Types: Remove all oil, grease, dirt, efflorescence, laitance, chemicals, hardeners, curing membranes, wax, previously applied coatings or other surface containments. Floors may be cleaned with an alkaline detergent dissolved in hot water, scrubbed with a non-metallic stripping pad and rinsed several times. Alternatively, clean using steam, water (low pressure), air blast, vacuum, and broom cleaning methods as described in ASTM D 4258 and SSPC-SP-1.

Concrete Floors: Roughen surface by abrading or etching. Concrete may be etched with a 20% phosphoric acid solution, mechanically scrubbed, and rinsed with a neutralizing solution (2 lb. Sodium bicarbonate and 1 gal. Water) and followed by a clean water rinse. Alternatively, abrade by steel shot blasting, sandblasting, water jetting with abrasive, power tool cleaning, or scarifying as described in ASTM D 4258 and NACE RP-01-72.

- 4.4 Perform a check for cleanliness by rubbing the floor with a clean, white cloth. If the cloth appears dirty, perform Step 4.3 again. Also check surface preparation by performing the following 'water-break' test: pour a small amount of clean water onto the surface and observe. If water evenly wets the surface, the cleaning is adequate. If the water forms beads on the surface, perform Step 4.3 again. Allow surfaces to completely dry before applying Adhesive or Coating.
- 4.5 Use 100 grit aluminum oxide or silicon carbide sandpaper to lightly sand the underside of the Barrier Strips and the mating surfaces of the connector plates. Wipe all sanding debris from the Barrier Strips with a clean rag.
- 4.6 Inspect the floor inside the containment area for any progressive cracks greater than 1/8 inch in width, as well as for control/expansion joints. Such surface defects must be repaired or filled with a Joint/Crack Filler before progressing any further with the Spill Control System installation. Smaller defects may be filled using Adhesive and a putty knife. A Joint/Crack Filler Kit is available from Alpha Industrial Power.



Figure 5.1 – Mixing the Adhesive



Figure 5.2 – Preparing Mixing Bag for Application

5. Barrier Installation

- 5.1 Lay out the Barrier Strips on the floor around the battery stand location in the order demonstrated in Figure 3.1 and lightly bolt the pieces together using carriage bolts, washers, nuts and the appropriate connector plates. Position the barrier around the battery stand location to provide equal clearances on all sides between the battery stand and the barrier. Note that the horizontal flange on all of the barrier strips faces the battery stand (Figure 3.1). This orientation is important both for barrier clearance and liquid-tight integrity.

CAUTION:

Barrier strips and connectors are constructed from steel and coated with an acid resistant epoxy. These strips should be handled with care near all electric power sources. Contact with an electrical source could result in severe shock or death. This product should only be installed by trained professionals familiar with the electrical hazards of high energy DC back up power systems.

- 5.2 After assembling and positioning the barrier system, mark the outer perimeter of the barrier on the floor using 1 inch masking tape. This will mark the proper placement of the Barrier and will help keep the floor clean from adhesive overage or coating splatters and drips.
- 5.3 Check for uneven flooring by measuring the gap between the bottom of the barrier and the floor. Gaps greater than 1/8 inch should be marked for the application of additional Adhesive material during the barrier assembly process. After marking large gaps, disassemble the parts for application of Adhesive and final assembly.
- 5.4 Prepare Adhesive by removing the separator between Part A and Part B in the two part pouch. Knead the package vigorously and work the material from end to end until the epoxy appears thoroughly mixed. To ensure complete and thorough mixing, continue kneading for several minutes after the Adhesive material has achieved an even consistency and color. Poorly mixed Adhesive will not fully cure, resulting in a failure to bond the Barrier securely to the floor and to poor chemical resistance.

CAUTION:

The Adhesive and Coating materials are immediate eye irritants and, after prolonged exposure, skin and lung irritants. Wear safety goggles, long sleeved shirt, chemical resistant gloves and a NIOSH/MSHA TC-23C approved respirator (respirator required for inadequate ventilation situations only) when mixing and applying these compounds. See the MSDS for additional safety and handling instructions.

NOTE:

Once prepared, the Adhesive and Coating materials should be applied without delay. Interaction between Part A and Part B of the Adhesive generates heat that will accelerate the hardening process. Always grasp pouch by the rolled end to avoid discomfort due to heat generation.

- 5.5 Roll the end of the bag such that the empty space has been taken up (Figure 5.1). Diagonally cut one of the bottom corners so that the bag may be used as an applicator (Figure 5.2). Squeezing the bag will apply a bead of Adhesive.
- 5.6 Use the Adhesive to fill any defects in the floor inside the containment area that have not been previously filled using the Joint/Crack Filler Kit. Use a putty knife to scrape the filled areas flush with the surrounding surface.

- 5.7 In facilities where a battery rack is already installed, use a spreader or putty knife to seal the base of the battery rack with Adhesive as shown in Figure 5.3. Using a brush, apply Adhesive to the battery rack anchoring hardware as shown in Figure 5.4.
- 5.8 Starting at one corner, apply a thick bead of Adhesive to the bottom surface of two of the Barrier Strips and spread evenly over the flange with a 3/16 inch v-notch trowel. Use the 1/4 inch v-notch trowel if additional adhesive is required for filling gaps. Press the strips into place on the floor and align them to the markings made in Step 4.3.
- 5.9 Apply Adhesive to the mating surfaces of the Corner Plate, spread the Adhesive evenly over the surface using a 1/8 inch v-notch trowel, and press the plate into place over the joint (Figure 5.5). Lightly bolt the Corner Plate to the Strips using a carriage bolt, flat washer and hex bolt arrangement.
- 5.10 Proceed along the Barrier perimeter while repeating steps 5.6 and 5.7. Use a Splice Plate where joining Strips is required (Figure 5.6).

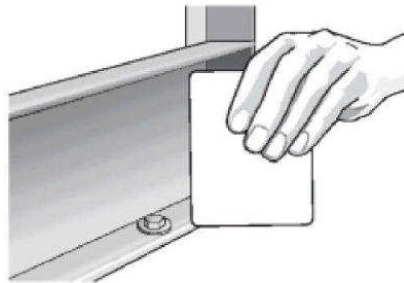

Figure 5.3 – Sealing Rack Frames

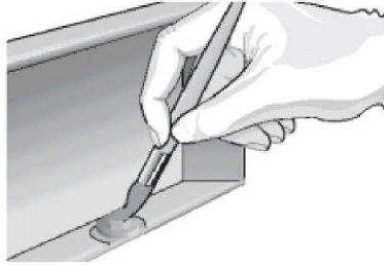

Figure 5.4 – Coating Rack Hardware

- 5.11 At each corner joint, apply a bead of Adhesive over the mitered seam and spread the material flush with a putty knife.
- 5.12 Recheck the alignment and position of the barrier and its components and tighten all of the assembly hardware using a 7/16 inch box-end or combination wrench. The hardware has been properly tightened when Adhesive material starts to squeeze out evenly around the edges of the connector plates. Avoid over tightening as this will cause an Adhesive-starved joint. Use a putty knife to scrape away the excess adhesive and use it to fill any voids under the Barrier Strips.
- 5.13 Clean any Adhesive that has been spilled using a cloth lightly dampened with denatured or rubbing alcohol.
- 5.14 Retain any mixed Adhesive that is left over for leak repair during the coating process. If leak repair is not necessary, allow the Adhesive to harden in its container and dispose of in accordance with local, state and federal regulations.
- 5.15 If installing a Barrier System without floor coating, remove masking and proceed to Section 7 for information on performing a leak test of the Barrier.

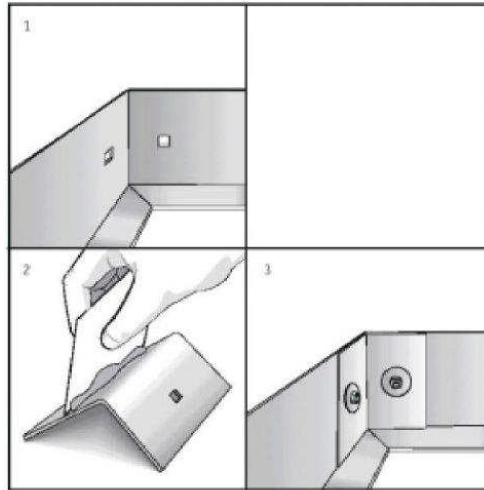

Figure 5.5 – Assembling Barrier

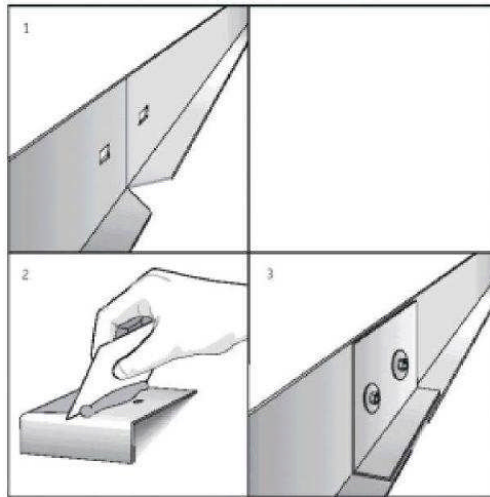

Figure 5.6 – Assembling Barrier Splices

6. Coating Application (Barrier System with floor coating version only)

- 6.1 Verify that the proper quantities of Acidsafe Floor Coating Part A and Part B are matched up properly in preparation for mixing. A 1 gallon kit will be comprised of one 1 gallon can of Part A and a 1 quart can of Part B.
- 6.2 Pour all of Part B into a corresponding container of Part A and blend with a rotary stirrer and an electric drill on moderate speed (approximately 700 rpm). Keep the stirring vanes well below the surface of the Coating to avoid entraining air bubbles into the mixture. Continue to stir the Coating compound for several minutes after the mixture has achieved an even color and pay special attention to unmixed material at the sides and bottom of the container. Mix additional Coating as necessary during the coating process to complete the installation. Improperly mixed Coating will not completely cure, resulting in reduced chemical resistance and poor performance.
- 6.3 Pour and spread the Coating evenly over the floor inside the containment area using a plastic spreader or putty knife (Figure 6.2). If installing the coating under an existing rack, try to allocate equal amounts of coating material between each set of rack frames. Spread the coating using a 1/4 inch v-notch spreader to obtain a uniform thickness. Figure 6.1 shows coating being applied under a rack. Note that the batteries are not illustrated for reasons of clarity; batteries DO NOT need to be removed in order to apply the coating.

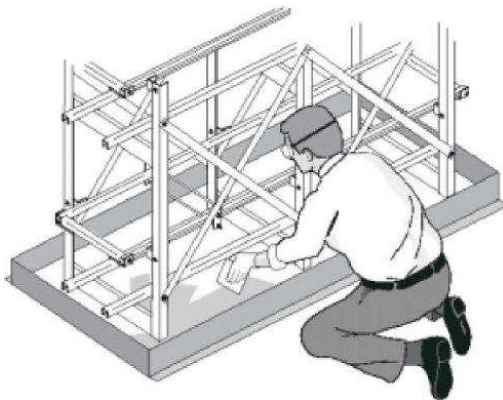

Figure 6.1 – Spreading Acidsafe Around Existing Racks

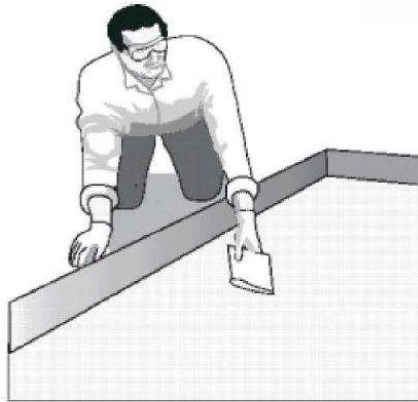

Figure 6.2 – Spreading Acidsafe in New Installations

- 6.4 Check that Coating thickness in all areas is at least 5/64 inches using a small metal ruler or 80 mils on a film gauge. Spread the Coating as necessary to achieve a uniform thickness. If the film thickness in an area is insufficient, pour additional Coating or use the spreader to redistribute the Coating as necessary.
- 6.5 Use a spiked pin roller (available in the Coating Installation Tool Kit) to rupture any air bubbles. If no spiked pin roller is available or in places that the spiked pin roller is unable to reach, break the surface of any bubbles seen by probing them with an unfolded paper clip.
- 6.6 Inspect the perimeter of the barrier for seepage. If Coating is seeping under the barrier, use a spreader or gloved finger to force some remaining Adhesive under the Barrier in the area of the leak until the flow stops. If no usable Adhesive remains, a piece of Coating-saturated paper towel may also be used.
- 6.7 Remove the masking tape from the floor around the barrier.

- 6.8 Any mixed Coating that has been spilled may be absorbed with cat litter box filler and wiped up with a cloth moistened with denatured or rubbing alcohol. Allow remaining Coating material to harden in its container and dispose of in accordance with local, state and federal regulations.
- 6.9 In installations where Coating is installed before the battery system, racks may be positioned only after the Coating has been completely cured. If a leak test is to be performed, it also must be satisfactorily completed prior to rack installation. Do not load the racks with batteries until the Coating has had at least one week to completely cure. Once the battery racks have been installed, obtain a Leak Repair Kit (part number 5LRK0001) and use it to seal the frames (Figure 5.3) and anchors (Figure 5.4).

7. Leak Test

- 7.1 The barrier leak test is an optional procedure to verify the liquid-tight integrity of the Spill Control System. After the Coating and the Adhesive have been permitted to cure for 24 hours, perform a leak test by filling the Barrier system with water and allowing it to stand while checking for leaks. If any leakage occurs, identify and mark the unsealed location.
- 7.2 Drain the barrier and make sure the floor is clean and dry. In most cases, a wet/dry shop vacuum is the quickest and easiest method to remove the water from the barrier.
- 7.3 If leakage is found, obtain a Leak Repair Kit from Alpha Industrial Power. Follow the enclosed instructions to mix an appropriate quantity of Adhesive and brush it over the area of the leak until the crack or seam is no longer evident. Allow the repair 24 hours to cure before retesting.

8. Coating Maintenance

- 8.1 Coating integrity is important to the effectiveness of the Barrier system. The elastic nature of the Coating typically resists cracking and chipping in a conventional battery room environment and no reapplications are likely to be required for the lifetime of the battery system. However, extreme conditions or circumstances may damage the surface of the Coating. For that reason, it must undergo periodic inspection and occasional repair.
- 8.2 If the battery facility has experienced an earthquake or other event in which damage to the floor has occurred in the area of the Barrier, remove the Neutra-Mats and perform an inspection of the floor inside the barrier to detect any cracks or breaks in the Coating. Fill a one quart atomizing bottle with at least 16 ounces of distilled water, 1 to 2 fluid ounces of food dye and 6 to 8 drops of a surfactant such as Dawn or Ivory liquid dish soap. Shake well and mist the suspect area. Wipe the sprayed area with a damp rag and any fractures will appear as dye-colored lines. If cracks or defects are found, repair as follows:
- 8.3 Obtain a Leak Repair Kit (part number 5LRK0001) from Alpha Industrial Power. Ensure that the area is completely dry. Sand an area at least 1 inch on all sides of the crack or chip for the entire length of the defect using 100 grit aluminum oxide or silicon carbide sandpaper. Remove any sanding debris.
- 8.4 Mix the Adhesive in the Leak Repair Kit and brush the repair material over the sanded area until the crack is no longer evident. Allow the repair 24 hours to cure before placing anything on top of it, such as Neutra-Mats.
- 8.5 For cracks larger than 1/8 inch in width, ensure that no structural damage has occurred that will endanger the battery facility. Obtain a Joint/Crack Filler Kit from Alpha Industrial Power and repair the crack in accordance with the enclosed instructions.

MATERIAL SAFETY DATA SHEET

1. MATERIAL IDENTIFICATION

Product Name: **ADHESIVE GEL (RESIN), PART-A**
Chemical Family: Epoxy Resin Mixture
Company Name: Eastern Resins Corp.
1174 River Street Woonsocket, RI
02895, USA

BUSINESS PHONE: (401) 769-6700
EMERGENCY PHONE: (800) 255-3924

2. COMPOSITION

| Chemical Name | Wt % | Exposure Limits | |
|---------------------|------|------------------|-------------|
| | | ACGIH TLV-TWA | OSHA PEL |
| Epoxy resin Mixture | >70 | N/E | N/E |
| Titanium Dioxide * | <10 | 10 mg/m3 | 15 mg/m3 |
| Carbon black* | <1 | 3.5 mg/m3 | 3.5 mg/m3 |
| Fumed silica* | <10 | 20 mppcf | 20mppcf |

Specific ingredients are considered a Trade Secret

Abbreviations: N/E - NOT ESTABLISHED

* - Materials are in Non-Airborne form

3. HEALTH HAZARDS

Primary Routes of Exposure: Eyes: Yes Skin: Yes Inhalation: Yes

Eye Contact: May cause irritation and swelling.
Skin Contact: May cause irritation and sensitization. Symptoms can be immediate or delayed several hours. **Inhalation:** May cause irritation and temporary or permanent sensitization.
Ingestion: May cause irritation.
Other: Preexisting skin sensitization may be aggravated by exposure to this product.

4. FIRST AID MEASURES

Eyes: Flush eyes thoroughly with water for at least 15 minutes while holding eyelids open. Seek medical attention.
Skin: Remove contaminated clothing. Wipe excess from skin and wash the affected area thoroughly with soap and water. Wash contaminated clothing thoroughly before reuse.
Inhalation: Remove to fresh air, and provide oxygen or artificial respiration if needed. Obtain medical attention; symptoms can be delayed up to several hours.
Ingestion: DO NOT induce vomiting. Give 1-2 cups of water or milk unless the person is drowsy, convulsing, or unconscious. Get medical attention.

5. FIRE FIGHTING MEASURES

Flammable Properties: Flash Point: >300°F (PMCC)
Explosive Limits: Not applicable **Auto-Ignition Temperature:** Not applicable
Hazardous Decomposition Products: Carbon monoxide, carbon dioxide, aldehydes, and other organic substances.

EXTINGUISHING MEDIA AND FIRE FIGHTING INSTRUCTIONS: When sufficiently large quantities are present, firefighters should be equipped with full bunker gear, including a positive pressure, NIOSH approved, self-contained breathing apparatus. Extreme heat or water contamination may cause closed containers to explode.

Extinguishing Media: Use carbon dioxide, dry chemical or appropriate foam

6. ACCIDENTAL RELEASE MEASURES

Ventilate the spill area and evacuate if necessary. Remove all ignition sources. Dike and contain large spills. Clean-up personnel should use adequate protective equipment.

7. HANDLING AND STORAGE

Store in a cool, dry place, in closed containers at room temperature. Avoid contact with incompatible materials. Wear protective eyewear, chemical-resistant gloves, and other protective clothing as appropriate.

8. EXPOSURE CONTROL AND PERSONAL PROTECTION

Engineering/Ventilation Controls: Effective engineering controls should be used whenever possible to eliminate and/or reduce worker exposure to all respiratory hazards. General ventilation, local ventilation, or isolation may prove adequate to keep airborne concentrations below exposure limits.

Respiratory Protection: Not required under normal conditions in a well-ventilated workplace.

Skin Protection: Impervious gloves and protective clothing should be worn as necessary.

Eye Protection: Chemical splash goggles or safety glasses with side shields should be worn as appropriate.

9. STABILITY AND REACTIVITY

Chemical Stability: Stable under normal conditions and use.

Conditions and Materials to Avoid: Reacts with amines and strong oxidizing agents. **Hazardous Polymerization:** Will not occur.

10. PHYSICAL AND CHEMICAL PROPERTIES

| | | |
|--------------------------------|-------------------------------|--------------------------------------|
| Appearance/Odor: | Gray Paste, slight ether odor | Boiling Point: Not determined |
| Vapor Pressure (mm Hg): | <1 @ 25°C | Vapor Density (air=1) : >1 |
| Specific Gravity: | 1.2-1.3 | Solubility in Water: None |

11. TOXICOLOGICAL INFORMATION

This section provides toxicological information with regard to the pure form of the component indicated. It is suggested that persons trained in its evaluation interpret this information.

| | | |
|----------------------|---|-----------|
| Epoxy Resins: | Acute Oral <small>LD50</small> (Rat): | 11.4 g/kg |
| | Acute Dermal <small>LD50</small> (Rabbit): | >20 g/kg |

12. DISPOSAL CONSIDERATIONS

Keep out of surface waters, sewers, and waterways entering or leading to surface waters. Notify authorities if any exposure to the environment occurs or is likely to occur. Utilize an appropriate disposal facility, in compliance with applicable federal, state, and local environmental control regulations.

13. TRANSPORTATION INFORMATION

DOT/IATA Proper Shipping Name: Not Regulated

14. REGULATORY INFORMATION

TSCA: The chemical components of this product are included in the TSCA Chemical Substance Inventory, as required.

SARA TITLE III:

Section 313 – Toxic Chemicals: None

Section 311/312 – Hazard Categories:

| | | | |
|---|----|---|-----|
| Fire Hazard: | No | Reactivity Hazard: | No |
| Sudden Release of Pressure Hazard: | No | Immediate (Acute) Health Hazard: | Yes |
| Delayed (Chronic) Health Hazard: | No | | |

OSHA Hazard Communication Standard Hazard Classes:

| | | |
|--------------------------------|-----------------|---------------|
| NFPA Hazards: Health: 2 | Flammability: 1 | Reactivity: 0 |
| HMS Hazards: Health: 2 | Flammability: 1 | Reactivity: 0 |

This information is furnished without warranty, expressed or implied, except that it is accurate to the best of our knowledge. The data on this sheet relates only to the specific material designated herein. **Eastern Resins Corp.** assumes no legal responsibility for use or reliance upon these data.

MATERIAL SAFETY DATA SHEET

1. MATERIAL IDENTIFICATION

Product Name: **ADHESIVE GEL (HARDENER), PART-B**
Chemical Family: AMINE MIXTURE
Company Name: Eastern Resins Corp.
1174 River Street
Woonsocket, RI 02895, USA

BUSINESS PHONE: (401) 769-6700
EMERGENCY PHONE: (800) 255-3924

2. COMPOSITION

| Chemical Name | Wt % | Exposure Limits | |
|----------------------|-------|-----------------|----------|
| | | ACGIH TLV-TWA | OSHA PEL |
| Cycloaliphatic amine | 50-70 | N/E | N/E |
| Aliphatic amine | 30-50 | N/E | N/E |

Specific ingredients are considered a Trade Secret

Abbreviations: N/E - NOT ESTABLISHED

* - Materials are in *Non-Airborne* form

3. HEALTH HAZARDS

Primary Routes of Exposure: Eyes: Yes Skin: Yes Inhalation: Yes
Eye Contact: Cause severe irritation and may cause burn.
Skin Contact: Cause irritation and sensitization. Symptoms can be immediate or delayed several hours.
Inhalation: Can cause respiratory tract irritation.
Ingestion: Can cause nausea, headache, and gastrointestinal irritation.
Other: Preexisting skin sensitization may be aggravated by exposure to this product.

4. FIRST AID MEASURES

Eyes: Flush eyes thoroughly with water for at least 15 minutes while holding eyelids open. Seek medical attention.
Skin: Remove contaminated clothing. Wipe excess from skin and wash the affected area thoroughly with soap and water. Wash contaminated clothing thoroughly before reuse.
Inhalation: Remove to fresh air, and provide oxygen or artificial respiration if needed. Obtain medical attention; symptoms can be delayed up to several hours.
Ingestion: DO NOT induce vomiting. Give 1-2 cups of water or milk unless the person is drowsy, convulsing, or unconscious. Get medical attention.

5. FIRE FIGHTING MEASURES

Flammable Properties: Flash Point: >200°F (PMCC)
Explosive Limits: Not applicable **Auto-Ignition Temperature:** Not applicable
Hazardous Decomposition Products: oxides of nitrogen, Carbon monoxide, carbon dioxide and other organic materials.

EXTINGUISHING MEDIA AND FIRE FIGHTING INSTRUCTIONS: When sufficiently large quantities are present, firefighters should be equipped with full bunker gear, including a positive pressure, NIOSH approved, self-contained breathing apparatus. Extreme heat or water contamination may cause closed containers to explode.

Extinguishing Media: Use carbon dioxide, dry chemical or appropriate foam.

6. ACCIDENTAL RELEASE MEASURES

Ventilate the spill area and evacuate if necessary. Remove all ignition sources. Dike and contain large spills. Flush area with water spray. Clean-up personnel should use adequate protective equipment.

7. HANDLING AND STORAGE

Store in a cool, dry place, in closed containers at room temperature. Avoid contact with incompatible materials. Wear protective eyewear, chemical-resistant gloves, and other protective clothing as appropriate.

8. EXPOSURE CONTROL AND PERSONAL PROTECTION

Engineering/Ventilation Controls: Effective engineering controls should be used whenever possible to eliminate and/or reduce worker exposure to all respiratory hazards. General ventilation, local ventilation, or isolation may prove adequate to keep airborne concentrations below exposure limits.

Respiratory Protection: Not required under normal conditions in a well-ventilated workplace.

Skin Protection: Impervious gloves and protective clothing should be worn as necessary.

Eye Protection: Chemical splash goggles or safety glasses with side shields should be worn as appropriate.

9. STABILITY AND REACTIVITY

Chemical Stability: Stable under normal conditions and use.

Conditions and Materials to Avoid: Reacts with epoxy and strong oxidizing agents.

Hazardous Polymerization: Will not occur.

10. PHYSICAL AND CHEMICAL PROPERTIES

| | | | |
|-------------------------------|-------------------------------|--------------------------------|------------------|
| Appearance/Odor: | Amber liquid, ammoniacal odor | Boiling Point: | Not determined |
| Vapor Pressure (mmHg): | <1 @ 25°C | Vapor Density (air=1) : | > 1 |
| Specific Gravity: | 1.04 | Solubility in Water: | Slightly soluble |

11. TOXICOLOGICAL INFORMATION

Acute Toxicity Data: Not available

Chronic Toxicity Data: Not available

12. DISPOSAL CONSIDERATIONS

Keep out of surface waters, sewers, and waterways entering or leading to surface waters. Notify authorities if any exposure to the environment occurs or is likely to occur. Utilize an appropriate disposal facility, in compliance with applicable federal, state, and local environmental control regulations.

13. TRANSPORTATION INFORMATION

DOT/IATA Proper Shipping Name: Not Regulated

14. REGULATORY INFORMATION

TSCA: The chemical components of this product are included in the TSCA Chemical Substance Inventory, as required.

SARA TITLE III:

Section 313 – Toxic Chemicals: None

Section 311/312 – Hazard Categories:

| | | | |
|---|----|---|-----|
| Fire Hazard: | No | Reactivity Hazard: | No |
| Sudden Release of Pressure Hazard: | No | Immediate (Acute) Health Hazard: | Yes |
| Delayed (Chronic) Health Hazard: | No | | |

OSHA Hazard Communication Standard Hazard Classes:

| | | |
|--------------------------------|-----------------|---------------|
| NFPA Hazards: Health: 3 | Flammability: 1 | Reactivity: 0 |
| HMS Hazards: Health: 3 | Flammability: 1 | Reactivity: 0 |

This information is furnished without warranty, expressed or implied, except that it is accurate to the best of our knowledge. The data on this sheet relates only to the specific material designated herein. **Eastern Resins Corp.** assumes no legal responsibility for use or reliance upon these data.

MATERIAL SAFETY DATA SHEET

1. MATERIAL IDENTIFICATION

Product Name: **NOVOLAC FLOOR COATING (RESIN), PART-A**
Chemical Family: Epoxy Resin Mixture
Company Name: Eastern Resins Corp.
1174 River Street
Woonsocket, RI 02895, USA
BUSINESS PHONE: (401) 769-6700
EMERGENCY PHONE: (800) 255-3924

2. COMPOSITION

| Chemical Name | Wt % | Exposure Limits | |
|---------------------|------|-----------------|-----------|
| | | ACGIH TLV-TWA | OSHA PEL |
| Epoxy resin Mixture | >70 | N/E | N/E |
| Titanium Dioxide * | <10 | 10 mg/m3 | 15 mg/m3 |
| Carbon black* | <1 | 3.5 mg/m3 | 3.5 mg/m3 |

Specific ingredients are considered a Trade Secret

Abbreviations: N/E - NOT ESTABLISHED

* - Materials are in *Non-Airborne* form

3. HEALTH HAZARDS

Primary Routes of Exposure: Eyes: Yes Skin: Yes Inhalation: Yes

Eye Contact: May cause irritation and swelling.

Skin Contact: May cause irritation and sensitization. Symptoms can be immediate or delayed several hours.

Inhalation: May cause irritation and temporary or permanent sensitization.

Ingestion: May cause irritation.

Other: Preexisting skin sensitization may be aggravated by exposure to this product.

4. FIRST AID MEASURES

Eyes: Flush eyes thoroughly with water for at least 15 minutes while holding eyelids open. Seek medical attention.

Skin: Remove contaminated clothing. Wipe excess from skin and wash the affected area thoroughly with soap and water. Wash contaminated clothing thoroughly before reuse.

Inhalation: Remove to fresh air, and provide oxygen or artificial respiration if needed. Obtain medical attention; symptoms can be delayed up to several hours.

Ingestion: DO NOT induce vomiting. Give 1-2 cups of water or milk unless the person is drowsy, convulsing, or unconscious. Get medical attention.

5. FIRE FIGHTING MEASURES

Flammable Properties: Flash Point: >300°F (PMCC)

Explosive Limits: Not applicable

Hazardous Decomposition Products: Carbon monoxide, carbon dioxide, aldehydes, and other organic substances.

Auto-Ignition Temperature: Not applicable

EXTINGUISHING MEDIA AND FIRE FIGHTING INSTRUCTIONS: When sufficiently large quantities are present, firefighters should be equipped with full bunker gear, including a positive pressure, NIOSH approved, self-contained breathing apparatus. Extreme heat or water contamination may cause closed containers to explode.

Extinguishing Media: Use carbon dioxide, dry chemical or appropriate foam

6. ACCIDENTAL RELEASE MEASURES

Ventilate the spill area and evacuate if necessary. Remove all ignition sources. Dike and contain large spills. Clean-up personnel should use adequate protective equipment.

7. HANDLING AND STORAGE

Store in a cool, dry place, in closed containers at room temperature. Avoid contact with incompatible materials. Wear protective eyewear, chemical-resistant gloves, and other protective clothing as appropriate.

8. EXPOSURE CONTROL AND PERSONAL PROTECTION

Engineering/Ventilation Controls: Effective engineering controls should be used whenever possible to eliminate and/or reduce worker exposure to all respiratory hazards. General ventilation, local ventilation, or isolation may prove adequate to keep airborne concentrations below exposure limits.

Respiratory Protection: If exposure limits are exceeded and local ventilation is unavailable, a supplied-air respirator or a self-contained breathing apparatus is required.

Skin Protection: Impervious gloves and protective clothing should be worn as necessary.

Eye Protection: Chemical splash goggles or safety glasses with side shields should be worn as appropriate.

9. STABILITY AND REACTIVITY

Chemical Stability: Stable under normal conditions and use.

Conditions and Materials to Avoid: Reacts with amines and strong oxidizing agents.

Hazardous Polymerization: Will not occur.

10. PHYSICAL AND CHEMICAL PROPERTIES

| | | | |
|-------------------------------|--------------------------------|--------------------------------|----------------|
| Appearance/Odor: | Gray liquid, slight ether odor | Boiling Point: | Not determined |
| Vapor Pressure (mmHg): | <1 @ 25°C | Vapor Density (air=1) : | >1 |
| Specific Gravity: | 12 | Solubility in Water: | None |

11. TOXICOLOGICAL INFORMATION

This section provides toxicological information with regard to the pure form of the component indicated. It is suggested that persons trained in its evaluation interpret this information.

| | | |
|----------------------|---|--------------------|
| Epoxy Resins: | Acute Oral_{LD50}(Rat): | 11.4 g/kg |
| | Acute Dermal_{LD50}(Rabbit): | >20 g/kg |

12. DISPOSAL CONSIDERATIONS

Keep out of surface waters, sewers, and waterways entering or leading to surface waters. Notify authorities if any exposure to the environment occurs or is likely to occur. Utilize an appropriate disposal facility, in compliance with applicable federal, state, and local environmental control regulations.

13. TRANSPORTATION INFORMATION

DOT/IATA Proper Shipping Name: Not Regulated

14. REGULATORY INFORMATION

TSCA: The chemical components of this product are included in the TSCA Chemical Substance Inventory, as required.

SARA TITLE III:

Section 313 – Toxic Chemicals: None

Section 311/312 – Hazard Categories:

| | | | |
|---|----|---|-----|
| Fire Hazard: | No | Reactivity Hazard: | No |
| Sudden Release of Pressure Hazard: | No | Immediate (Acute) Health Hazard: | Yes |
| Delayed (Chronic) Health Hazard: | No | | |

OSHA Hazard Communication Standard Hazard Classes:

| | | |
|---------------------------------|------------------------|----------------------|
| NFPA Hazards: Health: 2 | Flammability: 0 | Reactivity: 0 |
| HMISH Hazards: Health: 2 | Flammability: 0 | Reactivity: 0 |

This information is furnished without warranty, expressed or implied, except that it is accurate to the best of our knowledge. The data on this sheet relates only to the specific material designated herein. **Eastern Resins Corp.** assumes no legal responsibility for use or reliance upon these data.

MATERIAL SAFETY DATA SHEET

1. MATERIAL IDENTIFICATION

Product Name: **NOVOLAC FLOOR COATING (HARDENER), PART-B**
Chemical Family: **AMINE MIXTURE**
Company Name: **Eastern Resins Corp.**
1174 River Street
Woonsocket, RI 02895, USA
BUSINESS PHONE: (401) 769-6700
EMERGENCY PHONE: (800) 255-3924

2. COMPOSITION

| Chemical Name | Wt% | Exposure Limits | |
|----------------------|-------|-----------------|----------|
| | | ACGIH TLV-TWA | OSHA PEL |
| Cycloaliphatic amine | 50-70 | N/E | N/E |
| Aliphatic amine | 30-50 | N/E | N/E |

Specific ingredients are considered a Trade Secret

Abbreviations: N/E - NOT ESTABLISHED

* - Materials are in Non-Airborne form

3. HEALTH HAZARDS

Primary Routes of Exposure: Eyes: Yes Skin: Yes Inhalation: Yes

Eye Contact: Cause severe irritation and may cause burn.

Skin Contact: Cause irritation and sensitization. Symptoms can be immediate or delayed several hours.

Inhalation: Can cause respiratory tract irritation.

Ingestion: Can cause nausea, headache, and gastrointestinal irritation.

Other: Preexisting skin sensitization may be aggravated by exposure to this product.

4. FIRST AID MEASURES

Eyes: Flush eyes thoroughly with water for at least 15 minutes while holding eyelids open. Seek medical attention.

Skin: Remove contaminated clothing. Wipe excess from skin and wash the affected area thoroughly with soap and water. Wash contaminated clothing thoroughly before reuse.

Inhalation: Remove to fresh air, and provide oxygen or artificial respiration if needed. Obtain medical attention; symptoms can be delayed up to several hours.

Ingestion: DO NOT induce vomiting. Give 1-2 cups of water or milk unless the person is drowsy, convulsing, or unconscious. Get medical attention.

5. FIRE FIGHTING MEASURES

Flammable Properties: Flash Point: >200°F (PMCC)

Explosive Limits: Not applicable

Auto-Ignition Temperature: Not applicable

Hazardous Decomposition Products: oxides of nitrogen, Carbon monoxide, carbon dioxide and other organic materials.

EXTINGUISHING MEDIA AND FIRE FIGHTING INSTRUCTIONS: When sufficiently large quantities are present, firefighters should be equipped with full bunker gear, including a positive pressure, NIOSH approved, self-contained breathing apparatus. Extreme heat or water contamination may cause closed containers to explode.

Extinguishing Media: Use carbon dioxide, dry chemical or appropriate foam.

6. ACCIDENTAL RELEASE MEASURES

Ventilate the spill area and evacuate if necessary. Remove all ignition sources. Dike and contain large spills. Flush area with water spray. Clean-up personnel should use adequate protective equipment.

7. HANDLING AND STORAGE

Store in a cool, dry place, in closed containers at room temperature. Avoid contact with incompatible materials. Wear protective eyewear, chemical-resistant gloves, and other protective clothing as appropriate.

8. EXPOSURE CONTROL AND PERSONAL PROTECTION

Engineering/Ventilation Controls: Effective engineering controls should be used whenever possible to eliminate and/or reduce worker exposure to all respiratory hazards. General ventilation, local ventilation, or isolation may prove adequate to keep airborne concentrations below exposure limits.

Respiratory Protection: If exposure limits are exceeded and local ventilation is unavailable, a supplied-air respirator or a self-contained breathing apparatus is required.

Skin Protection: Impervious gloves and protective clothing should be worn as necessary.

Eye Protection: Chemical splash goggles or safety glasses with side shields should be worn as appropriate.

9. STABILITY AND REACTIVITY

Chemical Stability: Stable under normal conditions and use.

Conditions and Materials to Avoid: Reacts with epoxy and strong oxidizing agents.

Hazardous Polymerization: Will not occur.

10. PHYSICAL AND CHEMICAL PROPERTIES

| | | | |
|--------------------------------|-------------------------------|-------------------------------|------------------|
| Appearance/Odor: | Amber liquid, ammoniacal odor | Boiling Point: | Not determined |
| Vapor Pressure (mm Hg): | <1 @25°C | Vapor Density (air=1): | >1 |
| Specific Gravity: | 1.0 | Solubility in Water: | Slightly soluble |

11. TOXICOLOGICAL INFORMATION

Acute Toxicity Data: Not available

Chronic Toxicity Data: Not available

12. DISPOSAL CONSIDERATIONS

Keep out of surface waters, sewers, and waterways entering or leading to surface waters. Notify authorities if any exposure to the environment occurs or is likely to occur. Utilize an appropriate disposal facility, in compliance with applicable federal, state, and local environmental control regulations.

13. TRANSPORTATION INFORMATION

DOT/IATA Proper Shipping Name: Not Regulated

14. REGULATORY INFORMATION

TSCA: The chemical components of this product are included in the TSCA Chemical Substance Inventory, as required.

SARA TITLE III:

Section 313 – Toxic Chemicals: None

Section 311/312 – Hazard Categories:

| | | | |
|---|----|---|-----|
| Fire Hazard: | No | Reactivity Hazard: | No |
| Sudden Release of Pressure Hazard: | No | Immediate (Acute) Health Hazard: | Yes |
| Delayed (Chronic) Health Hazard: | No | | |

OSHA Hazard Communication Standard Hazard Classes: Corrosive

| | | |
|--------------------------------|------------------------|----------------------|
| NFPA Hazards: Health: 3 | Flammability: 1 | Reactivity: 0 |
| HMIS Hazards: Health: 3 | Flammability: 1 | Reactivity: 0 |

This information is furnished without warranty, expressed or implied, except that it is accurate to the best of our knowledge. The data on this sheet relates only to the specific material designated herein. **Eastern Resins Corp.** assumes no legal responsibility for use or reliance upon these data.

MATERIAL SAFETY DATA SHEET**Section I****General Information****Manufacturer:**

*Acran Spill Containment, Inc.
105-D Snyder Road
South Plainfield, NJ 07080*

*Date Prepared:
8 September 2008*

Telephone Number for Information:
(908) 769-6915

**Neutra-Tube
P/N 7NTA0006
(FCM00702)**

**Neutra-Mat
P/N 5NMB0010
(FCM00703)**

Section II**Hazardous Ingredients and Identity Information**

Neutralizer/Absorber Blend CAS #: Trade Secret Weight >99% Nuisance Dust

OSHA PEL: 15mg/M³ Total dust, 5 mg/M³ Respirable dust ACGIH TLV:

10mg/M³ Total dust

*Color Change Agent CAS #: Trade Secret Weight <1%
Skin, Eye, and Respiratory Irritant*

Section III**Physical Data**

Boiling Point: N/A

Vapor Density: N/A

Melting Point: N/A

Liquid Density: N/A

Volatiles: 0%vol. 0%wt.

Evaporation Rate: N/A

Specific Gravity: 2.5

Solubility: 3.5% wt in water.

Appearance & Odor: Pillow containing a light tan powder. Odorless.

Section IV**Fire and Explosion Hazard Data**

Flash Point: Non-flammable

LEL: None UEL: None

Extinguishing Media: Water, Carbon Dioxide, or Appropriate Foam

*Special Firefighting Procedures: If large quantities of product are involved,
significant levels of CO₂ may be generated making necessary the use of a
self contained breathing apparatus (CO₂ is an asphyxiant at levels over 5%).*

Unusual Fire and Explosion Hazards: None

Section V**First Aid and Health Hazard Data**

Acute and Chronic Effects of Overexposure:

Eye Contact: Dusts may irritate the eyes. In case of eye contact, wash eyes with copious amounts of water for 15 minutes.

Skin Contact: Prolonged exposure may cause irritation. Irritant dose is 30 mg/3 days—mild irritation to human skin. In case of skin contact, immediately wash skin with soap and water.

Inhalation: Nuisance dust can aggravate chronic bronchial difficulties. Breathing dust may irritate the nose and throat and cause coughing or chest discomfort. If inhaled, remove to fresh air. Give artificial respiration if not breathing. If breathing is difficult, give oxygen.

Ingestion: Excessive oral doses (5g/kg) may produce gastrointestinal disturbance, alkalosis, and expansion in extracellular fluid. Oral toxicity is 4.22 g/kg Rat LD50. If swallowed and conscious, wash mouth with water and induce vomiting. Do not put anything in mouth of unconscious person. Seek immediate medical attention.

Section VI Reactivity DataStability: *Stable*Hazardous Polymerization: *Will not occur*Conditions to avoid: *Excessive heat, HF acid, magnesium with hydrogen, strong oxidizing agent.*Hazardous Decomposition Products: *Combustion byproducts may be CO, NOx, SOx. Heating may release dangerous levels of CO₂ gas.*

Neutra-Tube
P/N 7NTA0006
(FCM00702)

Neutra-Mat
P/N 5NMB0010
(FCM00703)

Section VII Spill or Leak ProceduresSteps To Be Taken In Case Material Is Released Or Spilled: *Sweep or scoop up into clean container. If bags are torn or damaged, avoid breathing dust.*Waste Disposal Method: *If unused, not classified as hazardous for landfill disposal (40 CFR Part 261). After absorption of hazardous or toxic liquid, dispose of in accordance with applicable federal, state and local regulations.*Section VIII Special Protection InformationRespiratory Protection: *Dust mask should be used if dust levels exceed PEL.*Ventilation: *No dust should be produced in normal usage. If dust is created during handling, keep dust levels below 10 mg/M³ Local Exhaust: See above*Special: *N/A*Mechanical (General): *See above* Other: *N/A*Skin Protection: *Gloves and lab coat, apron or coveralls*Eye Protection: *Use goggles or safety glasses to avoid irritation.*Work/hygienic practices: *Establish good personal hygiene and work practices. Always wash hands and face before eating, drinking or smoking.*Section IX Special PrecautionsPrecautions To Be Taken In Handling, Transportation, And Storage: *Store in a dry place to protect product from loss of performance. Handle with care not to puncture bags.*Other Precautions: *None*Section X Additional Regulatory Information*Product not regulated by the DOT*

This Product Safety Data Sheet is offered solely for your information, consideration and investigation. ACRAN, Inc. provides no warranties, either expressed or implied, and assumes no responsibility for the accuracy and completeness of the data contained herein.
