

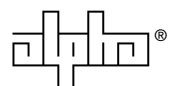

PN-6 and BD-8 Enclosure Installation Manual

Effective: June, 2003



Alpha PN-6 / BD-8 Powernode Enclosure Installation Manual

Effective: June, 2003

031-032-C2-002, Rev. B — © 2003 Alpha Technologies



PN-6/BD-8

Enclosure Installation Manual

031-032-C2-002, Rev. B
Effective Date: June, 2003
Copyright© 2003
Alpha Technologies, Inc.



NOTE: Alpha denies responsibility for any damage or injury involving its enclosures, power supplies, generators, batteries, or other hardware when used for an unintended purpose, installed or operated in an unapproved manner, or improperly maintained.



NOTE: Photographs contained in this manual are for illustrative purposes only. These photographs may not exactly match your installation.



NOTE: Review the drawings and illustrations contained in this manual before proceeding. If there are questions regarding the safe operation of this powering system, please contact Alpha Technologies or your nearest Alpha representative.

Contacting Alpha Technologies:

For general **product information and customer service**

1-800-863-3930

(7:00 AM to 5:00 PM Pacific Time)

For complete **technical support**

1-800-863-3364

(7:00 AM to 5:00 PM Pacific Time, or 24/7 emergency support)

Powernode Series Enclosures

Table of Contents

OVERVIEW

1.1	Introduction	10
-----	--------------------	----

PRE-INSTALLATION

2.1	Site considerations	11
2.2	Concrete Pad Dimensions	12
2.3	Site Cross Section	13
2.4	Enclosure Grounding	14

INSTALLATION

3.1	Enclosure Protection	15
3.2	Transportation and Lifting	16
3.3	Enclosure Installation	17
3.3.1	Attaching Enclosure to the pad	17
3.4	Utility Powering	18
3.4.1	Electrical Service Connection	18
3.5	Service Power Inserter	21
3.6	Battery Installation	22
3.6.1	Battery Safety	22
3.6.2	Battery Identification	22
3.6.3	Battery Terminal Connections	23
3.6.4	Battery Connection	24
3.6.5	Battery Connection, 36 Volt Battery Pack (BD-8)	25
3.6.6	Battery Connection, 48Volt Battery Pack (BD-8)	26
3.6.7	Battery Monitor Connections with Optional Status Monitoring Module	27
3.7	Power Supply Installation	28
3.7.1	Power Supply Installation	28
3.8	Battery Temperature Sensor	30
3.9	Lightning Arrester (LA-P+) Options	31
3.10	Part Numbers for Optional Equipment	32

Powernode

Series
Enclosures

List of Figures

OVERVIEW

Fig. 1-1	PN-6 with BD-8 battery enclosure	10
----------	--	----

PRE-INSTALLATION

Fig. 2-1	PN-6, Single-wide Cabinet Pad dimensions	12
Fig. 2-2	Pad Fabrication	13
Fig. 2-3	Enclosure Grounding	14

INSTALLATION

Fig. 3-1	Enclosure protection	15
Fig. 3-2	Enclosure Lifting Methods	16
Fig. 3-3	Service Entrance Wiring	19
Fig. 3-4	System Grounding	20
Fig. 3-5	Removing SPI Cover	21
Fig. 3-6	Connecting COAX to SPI Output Port	21
Fig. 3-7	Battery Hazards, Date Code Label	22
Fig. 3-8	Battery Terminal Connections	23
Fig. 3-9	BD-8 Battery Drawer	24
Fig. 3-10	Battery power distribution, 36 VDC	25
Fig. 3-11	Battery power distribution, 48 VDC	26
Fig. 3-12	SSC Battery Monitor Connections	27
Fig. 3-13	Battery Remote Temp Sensor (RTS) placement	30
Fig. 3-14	LAP Plus	31
Fig. 3-15	Line Surge Arrester	31

Product Safety

Important Safety Instructions Contained In This Manual Read This Manual Before Proceeding!

Review the drawings and illustrations contained in this manual before proceeding. If there are any questions regarding the safe installation or operation of the system, contact Alpha Technologies or the nearest Alpha representative. Save this document for future reference.

To reduce the risk of injury or death caused by electrical shock, explosion of fuel or moving parts; and to ensure the continued safe operation of this product, the following symbols have been placed throughout this manual. Where these symbols appear, use extra care and attention.



DANGEROUS VOLTAGE

This symbol indicates a “dangerous voltage” may exist in this area of the product. Use caution whenever working in the area to prevent electrical shock.



INHALATION HAZARD - DON'T BREATHE VAPORS

This symbol indicates an “inhalation hazard” may exist in this area of the product. Use caution whenever working in the area to prevent possible inhalation of harmful (fuel or exhaust) vapors.



NO MATCHES OR OPEN FLAMES

This symbol indicates a “fire or explosive hazard” may exist in this area of the product. Use caution whenever working in the area to prevent possible combustion of fuel vapors.



MECHANICAL OR MOVING PARTS HAZARD

These symbols indicate a “mechanical or moving parts hazard” may exist in this area of the product. Use caution whenever working in the area to prevent possible injury to the operator or service personnel.



LEAK HAZARD

This symbol indicates a “leak hazard” may exist in this area of the product. Use caution whenever working in this area to prevent and correct any leaks detected.



ATTENTION

This symbol indicates important installation, operation or maintenance instructions. Always follow these instructions closely.



NOTE: Alpha Technologies' products are subject to change through continual improvement processes. Therefore, specifications and/or design layouts may vary slightly from descriptions included in this manual. Updates to the manual will be issued when changes affect form, fit or function.

General Safety Precautions

A “**Warning**” identifies conditions and actions that pose a hazard to the user.

A “**Caution**” identifies conditions and actions that may damage the power supply or associated equipment.

Warnings



NOTE: This enclosure and its associated hardware (power supply, batteries, cabling) may contain equipment, batteries or parts which have accessible hazardous voltage or currents.

To avoid injury:

- This enclosure and its associated hardware must be serviced by authorized personnel only.
- Enclosure must remain locked at all times, except when authorized service personnel are present.
- Remove all conductive jewelry or personal equipment prior to servicing equipment, parts, connectors, wiring, or batteries.
- Read and follow all installation, equipment grounding, usage, and service instructions included in this manual.
- Use proper lifting techniques whenever handling enclosure, equipment, parts, or batteries.
- Batteries contain dangerous voltages, currents and corrosive material. Battery installation, maintenance, service and replacement must be performed by authorized personnel only.
- Never use uninsulated tools or other conductive materials when installing, maintaining, servicing or replacing batteries.
- Use special caution when connecting or adjusting battery cabling. An improperly connected battery cable or an unconnected battery cable can result in arcing, a fire, or possible explosion.
- A battery that shows signs of cracking, leaking or swelling must be replaced immediately by authorized personnel using a battery of identical type and rating.
- Avoid any contact with gelled or liquid emissions from a valve-regulated lead-acid (VRLA) battery. Emissions contain dilute sulfuric acid which is harmful to the skin and eyes. Emissions are electrolytic, which are electrically conductive and are corrosive. Follow the Chemical Hazards notes if contact occurs.
- Do not smoke or introduce sparks in the vicinity of a battery.
- Under certain overcharging conditions, lead-acid batteries can vent a mixture of hydrogen gas which is explosive. Proper venting of the enclosure is required.
- Follow the battery manufacturer’s approved transportation and storage instructions.

Cautions



NOTE: Enclosure, equipment or parts may be damaged or cause damage if used or installed improperly.

To avoid damage:

- Prior to installation, verify that the AC input voltage to the enclosure and its equipment match with respect to voltage and frequency.
- Prior to installation, verify that the output voltage from the enclosure or its equipment match the voltage requirements of the connected equipment (load).
- Prior to installation, verify that the enclosure's utility service panel is equipped with a properly rated circuit breaker for use with the equipment inside. Refer to manufacturer's recommendations.
- Review and upgrade utility service panel circuit breaker requirements whenever the equipment within the enclosure is changed.
- Prior to installation, contact local utilities, local building maintenance departments, and cable/piping locator services to ensure that installation does not interfere with existing utility or building cables/piping.
- Do not exceed the output rating of equipment. Verify load requirements prior and during connection process.
- Prior to handling the batteries, touch a grounded metal object to dissipate any static charge that may have developed in your body.

Battery Safety Notes

Lead-acid batteries contain dangerous voltages, currents and corrosive material. Battery installation, maintenance, service and replacement must be performed by authorized personnel only.

Chemical Hazards



NOTE: Any gelled or liquid emissions from a valve-regulated lead-acid (VRLA) battery contain dilute sulfuric acid, which is harmful to the skin and eyes. Emissions are electrolytic, which are electrically conductive and corrosive.

To avoid injury:

- Servicing and connection of batteries shall be performed by, or under the direct supervision of, personnel knowledgeable of batteries and the required safety precautions.
- Always wear eye protection, rubber gloves, and a protective vest when working near batteries. Remove all metallic objects from hands and neck.
- Batteries produce explosive gases. Keep all open flames and sparks away from batteries.
- Use tools with insulated handles, do not rest any tools on top of batteries.
- Batteries contain or emit chemicals known to the State of California to cause cancer and birth defects or other reproductive harm. Battery post terminals and related accessories contain lead and lead compounds. Wash hands after handling. (California Proposition 65)
- Wear protective clothing (insulated gloves, eye protection, etc.) whenever installing, maintaining, servicing, or replacing batteries.
- If any battery emission contacts the skin, wash immediately and thoroughly with water. Follow your company's approved chemical exposure procedures.
- If any battery emission contacts the eye, wash immediately and thoroughly with water for 10 minutes with pure water or a special neutralizing eye wash solution and seek immediate medical attention. Follow your company's approved chemical exposure procedures.
- Neutralize any spilled battery emission with the special solution contained in an approved spill kit or with a solution of 1 lb. Bicarbonate of soda to 1 gal of water. Report chemical spill using your company's spill reporting structure and seek medical attention if necessary.
- Always replace batteries with those of an identical type and rating. Never install old or untested batteries.
- Do not charge batteries in a sealed container. Each individual battery should have at least 0.5 inches of space between it and all surrounding surfaces to allow for convection cooling.
- All battery compartments must have adequate ventilation to prevent an accumulation of potentially dangerous gas.

1. Overview

1.1 Introduction

Alpha's PN Series Powernode enclosures offer complete flexibility and modular expandability for Cable TV powering applications. The PN-6 is designed for up to three XMS2 power supply and up to eight batteries. A 7.5 kW generator can be co-located for extended back-up power. For additional battery capacity, the BD-8 battery enclosure may be added.

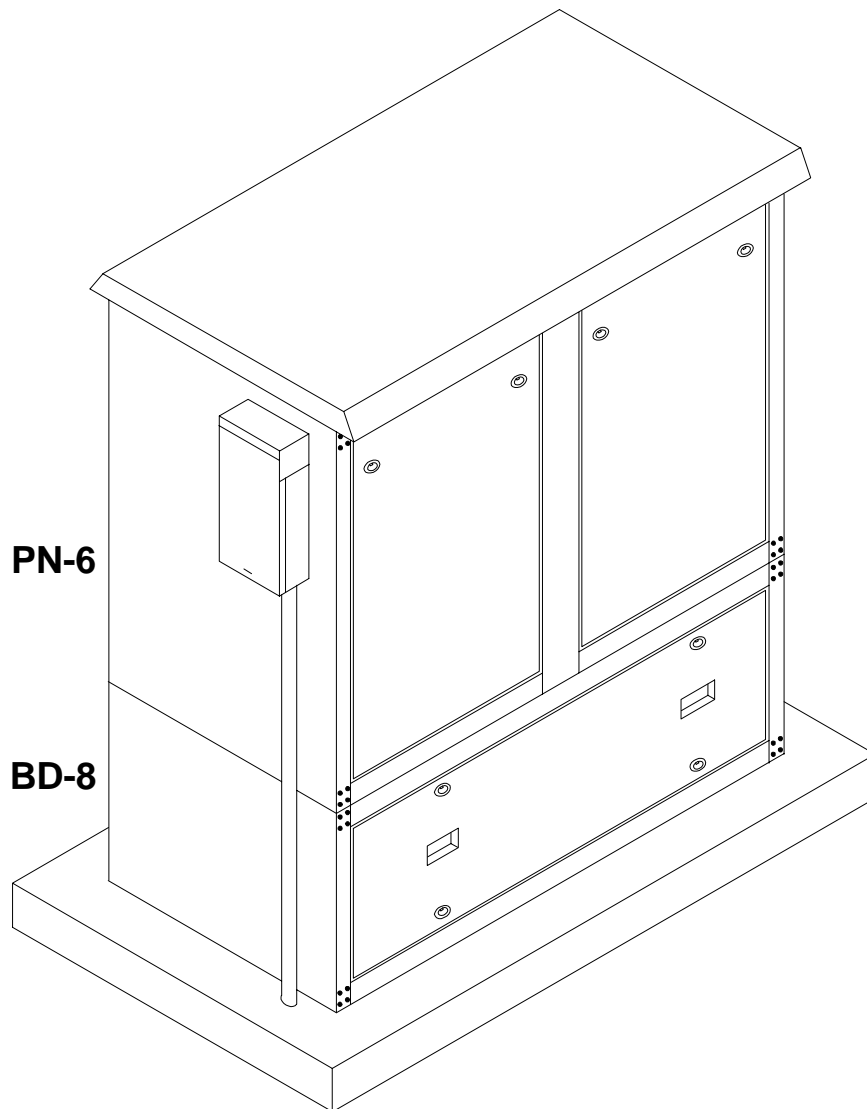

Fig. 1-1 PN-6 with BD-8 battery enclosure

2.1 Site considerations

The site must be planned so that the enclosure will receive good air flow. If possible, in areas of extreme heat, it is best to position the enclosure so that it will be shaded from the afternoon sun. In areas of prevailing winds, it is best that the enclosure be located so that the sides of the cabinet face the winds instead of the doors. This will greatly reduce the buildup of sand or snow against the enclosure's air vents.

In areas of potential flooding, the geographical site and concrete pad must be located above the 100 year flood plain.

The enclosure must be placed where it will be free of obstructions, allowing easy access to the doors for service or equipment access. For ventilation and maintenance, allow a minimum space of 36 inches in the front and 36 inches in the rear, between the enclosure and other solid structures.

Place the enclosure well away from ground level sources of forced water, such as underground sprinkler systems and direct roadway splash.

The concrete pad drawing provided in this manual contains all of the required mounting details, including electrical service and cable plant entrances.

For ease of installation, lightweight polymer concrete pads are available from Alpha Technologies for all PN series enclosures.

The vapor barrier material (such as 30 lb. felt, neoprene pond liner, or heavy grade tar paper) must initially extend at least 6" in all directions around the perimeter of the enclosure and be trimmed closer to the enclosure, after installation.



WARNING: **Never transport the unit with batteries installed.** Batteries must **ONLY** be installed after the unit is transported to the site and secured to the pad. Transporting the unit with batteries installed may cause a short circuit, fire, explosion, and/or damage to the battery pack, enclosure and installed equipment. Damage caused by improper shipping or transporting a unit with batteries installed is not covered by the warranty.

The batteries used in this application may vary slightly depending upon optional configurations, battery types, or customer requirements. The batteries are typically gelled-electrolyte, valve-regulated such as the AlphaCell™. Should a battery be found damaged, refer to the battery manufacturer's documentation regarding the safe handling of the battery.

2. Pre-Installation

2.2 Concrete Pad Dimensions

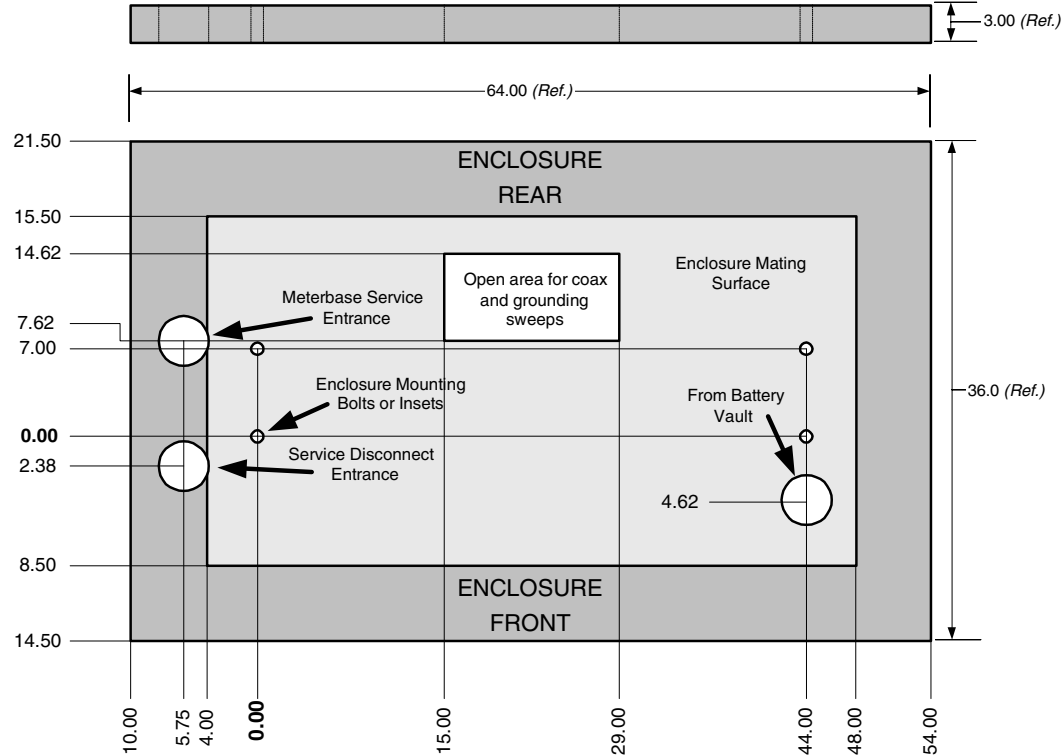

Fig. 2-1 PN-6, Single-wide Cabinet Pad dimensions
(Polymer Concrete Precast Pad P/N 641-089-10)

Pad can either be poured on site or precast by Alpha Technologies.

All dimensions shown in inches. Mounting holes and sweeps indexed from front left mounting stud or insert.

Alpha recommends a minimum distance of 6" from the enclosure wall and the edge of the pad.

All mounting hardware must be stainless steel, galvanized steel, or better to prevent corrosion.

A 25+ year continuous vapor barrier must be used between the enclosure and the pad to prevent moisture ingress and possible corrosion caused by metal to concrete contact. The vapor barrier material (such as 30 lb felt, neoprene pond liner, or heavy grade tar paper) must be initially extended at least 6" in all directions around the perimeter of the enclosure. After the enclosure is secured to the pad, the material can be cut closer to the enclosure, using the appropriate knife or cutting tool (see page 17).

2.3 Concrete Pad Installation

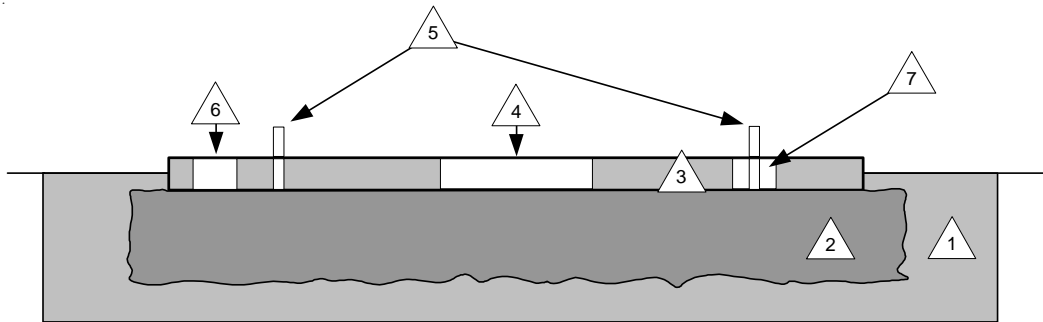

(Pour-in-place option shown)

- 1 Undisturbed Ground
- 2 Compacted Gravel (approx. 12")
- 3 Concrete Pad (3" to 6" thick)
- 4 Open area for output power and ground
- 5 1/2" -13 mounting studs or threaded inserts
- 6 Open area for utility power sweeps
- 7 Open area for Generator Interface Kit

Fig. 2-2 Site Cross Section

2. Pre-Installation

2.4 Enclosure Grounding



NOTE: Alpha Technologies recommends using the grounding method illustrated below. The grounding method for a particular site will be dependant upon soil type, available space, local codes, NEC (National Electric Code), and other site- specific characteristics.

Alpha Technologies recommends 5 ohms minimum ground resistance between enclosure and ground rods, in accordance with IEEE 1100-1999 Powering and Grounding Electronic Equipment. NEC minimum grounding standard is 25 ohms.

Alpha Technologies assumes no responsibility or liability for failure of the installer to comply with the requirements of all applicable local and national codes. Where allowed, exothermic welding may be used as an alternative to Burndy clamps and connectors.

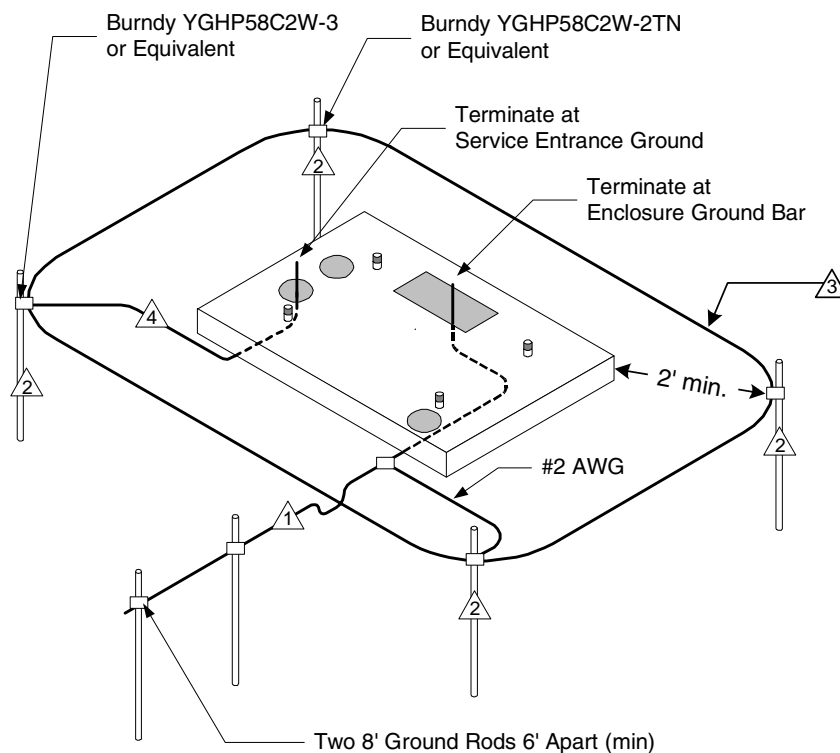

Fig. 2-3 Enclosure Grounding

(The above drawing is for reference only, is not to scale, and may lack some details)

Service Grounding (required)

- ① #6 bare copper wire from service entrance ground bar, with two ground rods 6' apart.

Lightning Protection (optional)

- ② 1/2" X 8' copper ground rods, four places.
- ③ #6 bare copper loop terminated at each ground rod, 30" below grade (min).
Corrosion-proof (25 yr. life-span) connections suitable for direct burial **MUST** be used.
- ④ #6 bare copper wire from loop to enclosure ground bar

3.1 Enclosure Protection

Alpha Technologies, Inc. cannot anticipate all of the ways a vehicle may potentially threaten an installed system or the specific type of protection that is appropriate for a particular location. The determination of the threat to the equipment and the means of protection are the responsibility of the end user of the equipment and the authority having jurisdiction. The following installation drawing for Alpha's Standby Power systems are general recommendations and not intended to be a specific guideline for protecting the equipment. The numbers of Bollard posts (or other protection devices) depend upon equipment locations, site surveys, and traffic patterns.

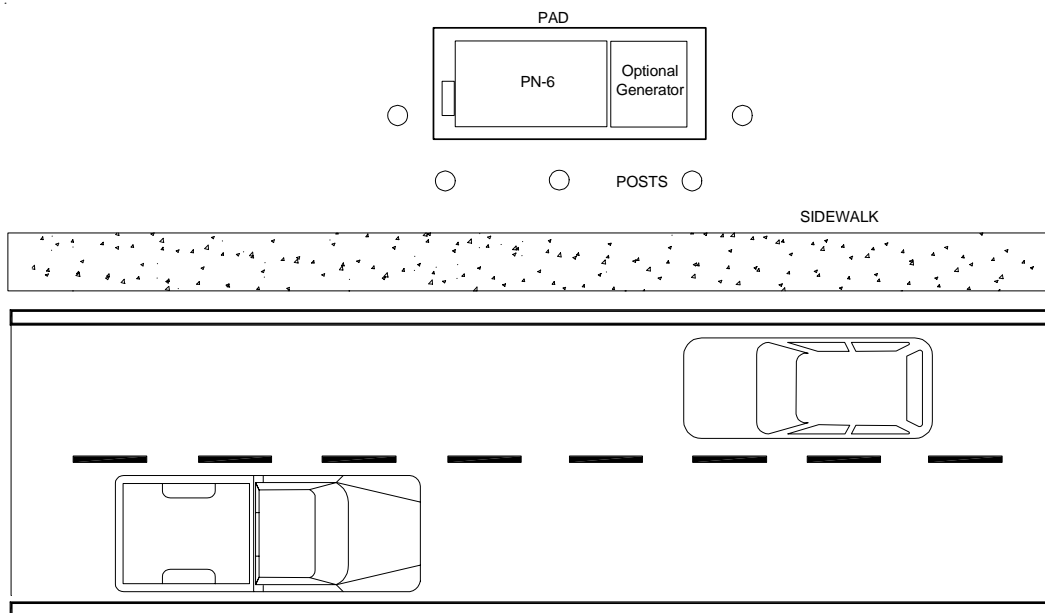

Fig. 3-1 Enclosure protection

3. Installation

3.2 Transportation and Lifting

The PN-6 cabinet as shipped, is extremely heavy. A safe means of transportation to the site and a safe procedure for unloading the enclosure is necessary. Do not transport or lift with a device that may not be able to bear the unit's weight, and do not place the unit upon a surface that will not be able to fully support it. Verify that the transport path is free of obstructions.



NOTE: Enclosure must always remain in the upright position during the shipping, storage and installation process. Damage may result from enclosure being shipped or stored on its side.



NOTE: Electronic modules, batteries or other components must **NOT** be installed until the enclosure is securely set in place at its permanent location.

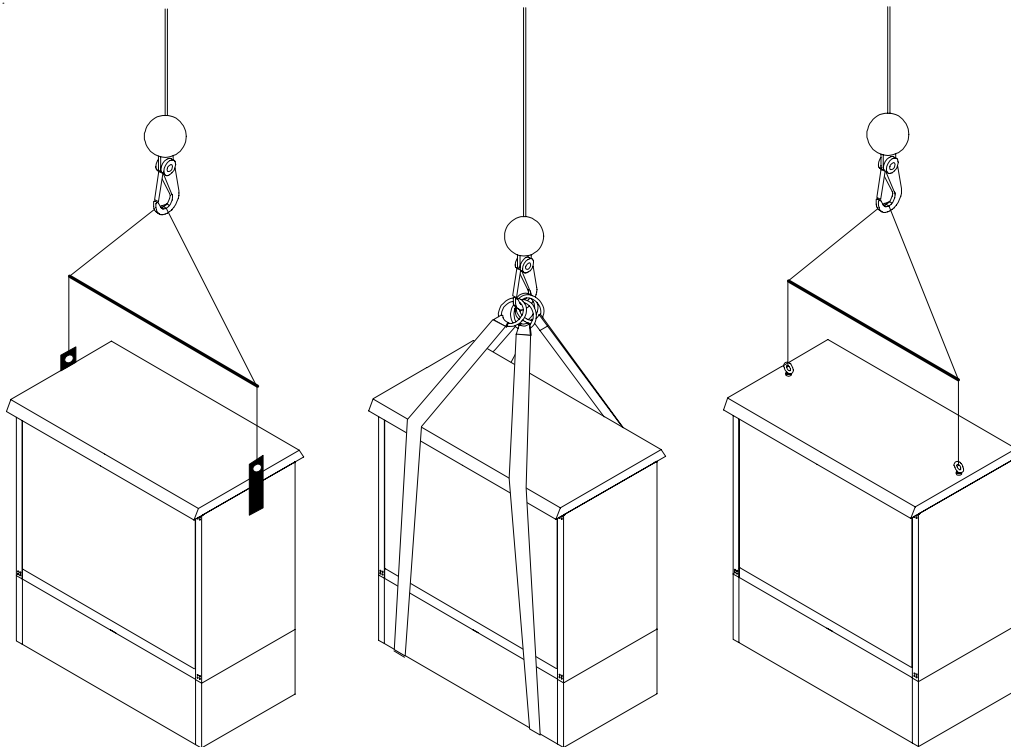

Fig. 3-2 Enclosure Lifting Methods

3.3 Enclosure Installation

3.3.1 Attaching Enclosure to the pad

Tools Needed:

Ratchet set with 6" extension.
Vapor Barrier
Utility Knife

Procedure:



NOTE: A 25+ year *continuous vapor barrier* must be used between the enclosure and pad to prevent moisture ingress and possible corrosion caused by metal to concrete contact. The vapor barrier material (such as 30 lb. felt, neoprene pond liner, or heavy grade tar paper) should initially be extended at least 6" in all directions around the perimeter of the enclosure.

1. Unwrap the enclosure and inspect the contents. If items are missing or damaged, contact Alpha Technologies and the shipper immediately.
2. Place the vapor barrier material on the pad.
3. Unbolt the enclosure from the shipping pallet.
4. Using an appropriate crane and spreader bar, lift the enclosure off the shipping pallet, and place over the mounting studs or inserts on the pad.
5. Secure the enclosure to the pour in place pad using four stainless steel flat washers, lockwashers, and nuts. Secure the enclosure to the pre cast pad using stainless steel bolts, flat washers and lock washers.
6. Trim the vapor barrier material.

3. Installation

3.4 Utility Powering

3.4.1 Electrical Service Connection

The XM2 Power Supplies are powered by either 120Vac or 240Vac (120/120 grounded neutral), attached to an external service entrance. The size of the service conductors must be based upon the actual size of the utility service and be in accordance with applicable electrical code requirements.

The utility conduit may be placed in two locations, depending upon the utility service entrance requirements. Note the optional conduit location for use with meter base and the standard location for entry directly to the load center.

Proper grounding is critical. The enclosure **MUST** have a hardwired ground to the service entrance. A qualified electrician should verify that grounding is in compliance with applicable electrical codes.



NOTE: All applicable codes must be adhered to when installing a system, pouring concrete, or placing a preformed pad. These codes supersede any procedures outlined in this document.



NOTE: All mounting hardware should be *stainless* or *galvanized steel*, depending on local environmental conditions. Use of improper hardware may cause corrosion which is not covered under warranty.



NOTE: Soil conditions vary and may affect the integrity of the pad. Alpha Technologies recommends that proper steps be taken to ensure that the soil supporting the pad is stable. Improper installation of the pad may cause uneven settling or cracking which is not covered under warranty.



CAUTION: The following should be performed only by qualified service personnel and in compliance with local electrical codes.

Verify electrical codes prior to installation. Codes may vary and contain specific conduit and wire sizes for connection to the service entrance.

Connection to utility power must be approved by the local utility before installing the power supply.

Materials Required:

- 1" dia. conduit - PVC or Galvanized Steel (threaded)
- #6 AWG - Red /stranded insulated wire
- #6 AWG - Black / stranded insulated wire
- #6 AWG - White / stranded insulated wire
- #2 AWG or larger - Stranded copper ground wire

3.4 Utility Powering, *continued*

3.4.1 Electrical Service Connection, *continued*

Tools Needed:

No. 1 Flat Head Screwdriver
Adjustable Pliers (Channel-Lock)

Procedure:

1. Locate the service entrance panel on the enclosure (exterior). Remove the cover to access the circuit breaker assembly. If this service panel is to be used as the primary service entrance, neutral must be bonded to ground.
2. Connect one of the black #6 wires to the bottom of the left side of the input circuit breaker (Line 1), and the remaining black (or red) #6 wire to the right side of the input circuit breaker (Line 2). Connect the #6 white wire to the top of the neutral bus to the right of the circuit breakers.

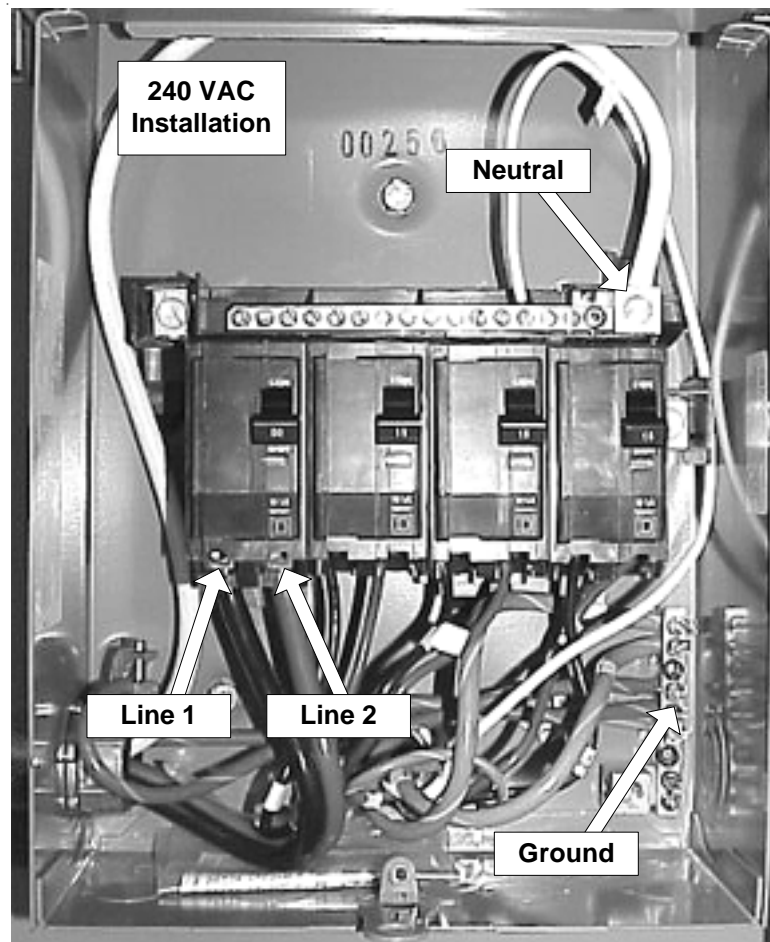

Fig. 3-3 Service Entrance Wiring

3. Installation

3.4 Utility Powering, *continued*

3.4.1 Electrical Service Connection, *continued*

3. Connect the #6 green ground wire to the large terminal on the ground bar.
4. Notify the electrical inspector to approve the service entrance wiring. Once approved, contact the local power utility for electrical service.

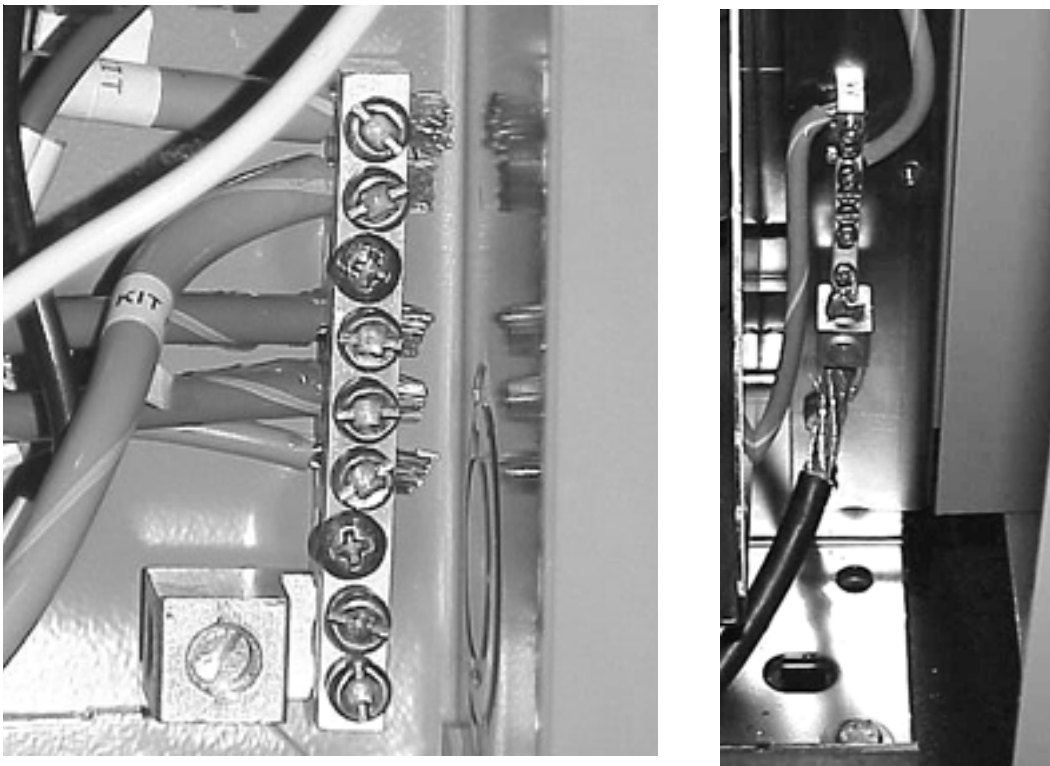

Fig. 3-4 System Grounding

3.5 Service Power Inserter

1. The SPI box(es) are mounted on a bracket behind the top power supply.
2. Remove the two screws on the face of the SPI and lift off the cover to gain access to the Seizure Screw Assembly. Loosen the Seizure Screw several turns so that the stinger will pass through the clamp (Fig. 3-5).
3. Insert the Coaxial Termination into the output port on the bottom of the SPI. Verify the stinger goes through the Seizure Screw Assembly. Tighten the Coaxial Termination (Fig. 3-6).
4. Tighten the seizure screw to 35.0 Inch-Pounds. Replace the SPI cover and screws. Inadequately tightened seizure screws will result in high resistance contact, increased contact heat, and possible contact failure.

Verify the switch on the top of the SPI is in the ON position. The AUX position is used only when an alternate power source is connected to the 'Jones' (in 15A rated SPI units) or 'Innergy' connector (in 25A rated SPI units) on the top of the SPI.

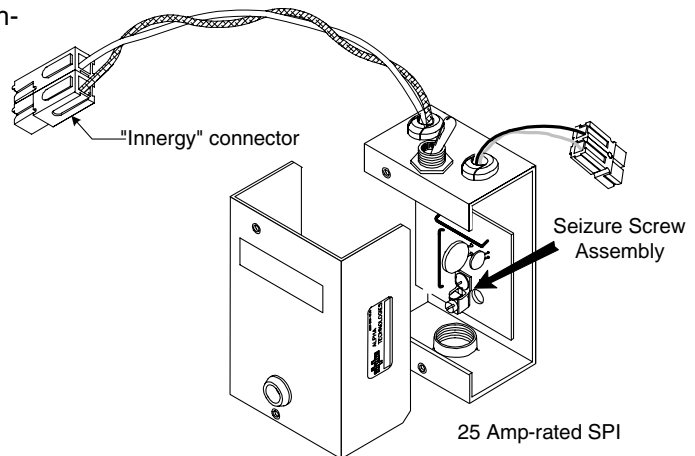
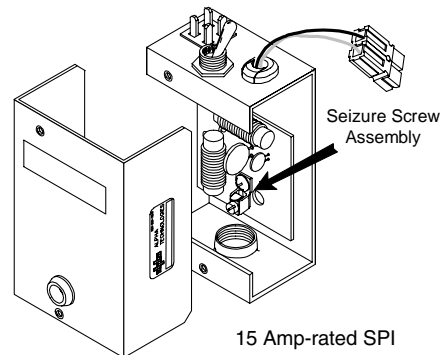

Fig. 3-5 Removing SPI Cover

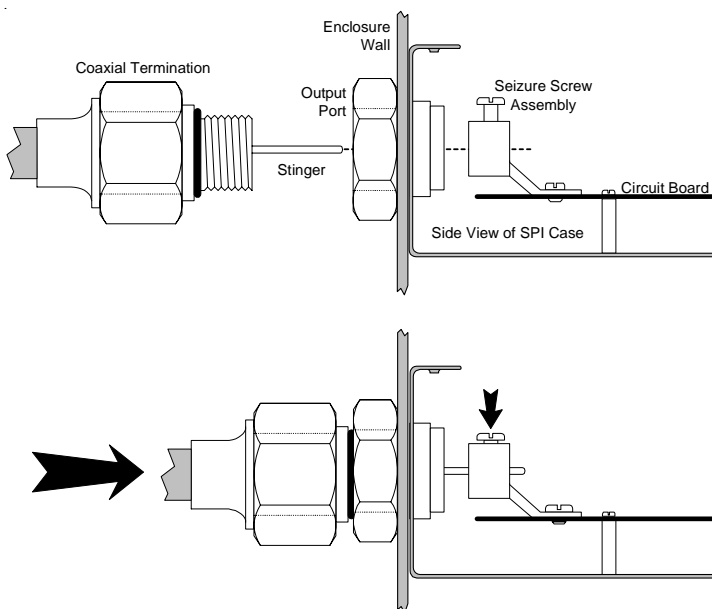

Fig. 3-6 Connecting COAX to SPI Output Port

3. Installation

3.6 Battery Installation

3.6.1 Battery Safety

Battery systems represent a risk of electrical shock and high short circuit currents. The following precautions must be observed when maintaining batteries:

- Remove all personal metal objects (watches, rings, etc.).
- Use insulated tools.
- Wear eye protection, rubber gloves and protective vest.
- Observe circuit polarities.
- Do not make or break live circuits.
- Do not lay metal tools and hardware on top of the batteries.

The battery is enclosed in cabinets with limited access. Again, extreme caution must be exercised when maintaining and collecting data on the battery system.

3.6.2 Battery Identification

Each battery contains a DATE CODE usually located on a sticker near the center of the battery or stamped in white ink near the POS terminal. This date code must be recorded in the battery's maintenance log. If batteries other than those installed by Alpha are used, consult the battery's manufacturers' documentation for date code type and placement.

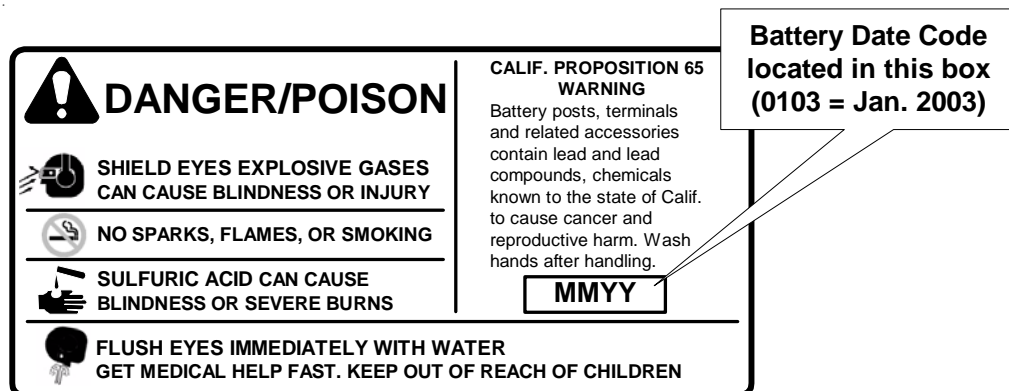

Fig. 3-7 Battery Hazards, Date Code Label

3.6 Battery Installation, *continued*

3.6.3 Battery Terminal Connections

The accompanying drawings are for *illustrative* purposes only. Various types of batteries with different mounting styles and hardware may be shipped with the system.

Mounting hardware requirements may vary with battery manufacturers. Use only the hardware recommended by your particular battery manufacturer.

The following illustration shows the typical terminal assembly for vertically mounted battery posts. The battery cables should be in direct contact with the battery post. All additional battery cables should be either in contact with the battery post or another battery cable, the battery cable stack-up should be limited to only two cables per side.

Using the hardware that is shipped with the Battery Cable Kit, make all battery connections as shown below. For AlphaCell™ batteries, follow the torque figures printed on the batteries. For other batteries, **ALWAYS** refer to the manufacturers' specifications for correct mounting hardware and torque requirements. During maintenance procedures, refer to the manufacturers' specifications for maintenance torque requirements.

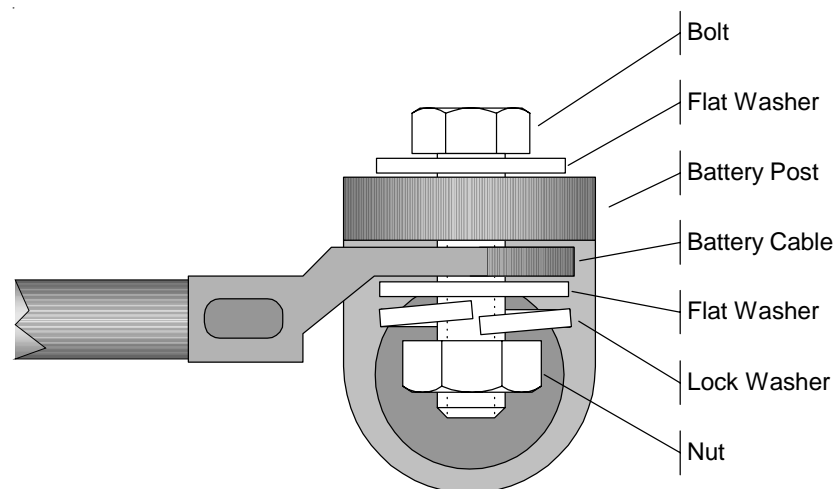

Fig. 3-8 Battery Terminal Connections

3. Installation

3.6 Battery Installation, *continued*

3.6.4 Battery Connection

Tools Needed:

Two 7/16" open end wrenches

Procedure:



Note: The BD-8 battery enclosure is an option, and may not be present.

1. Place batteries on the PN-6 battery trays, as shown in Fig. 3-10 or 3-11.
2. If the BD-8 enclosure is used, route the cables through the opening in the right front corner of the enclosures.
3. Connect the battery packs to the Battery Interface Unit at the top of the right side of the PN-6 enclosure.



Fig 3-9 BD-8 Battery Drawer

3.6 Battery Installation, *continued*

3.6.5 Battery Connection, Numbering for 36 Volt Battery Pack

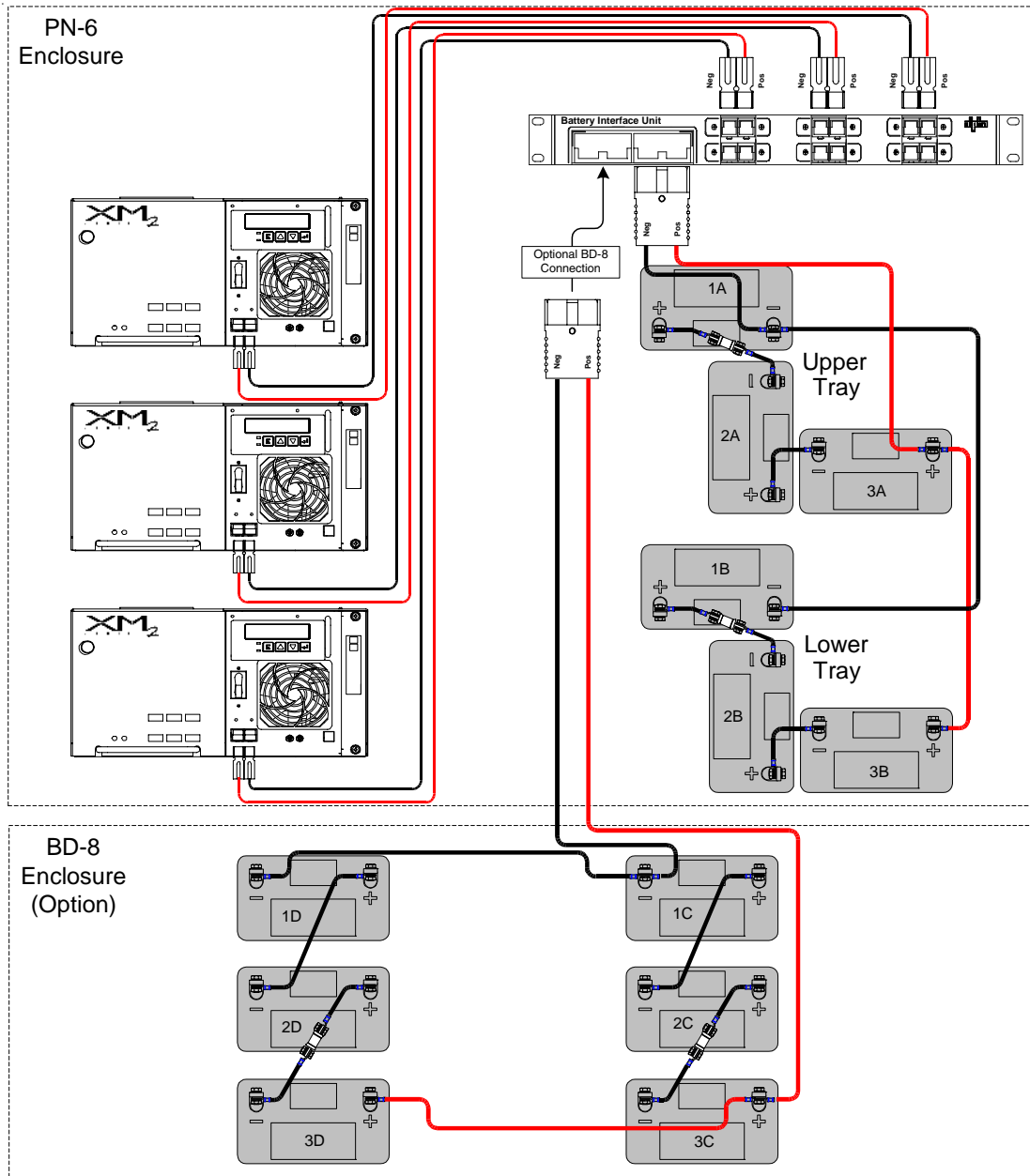

NOTE: Battery numbering scheme in accordance with SCTE guidelines for battery status monitoring.

Fig 3-10 Battery Power Distribution, 36 VDC

3. Installation

3.6 Battery Installation, *continued*

3.6.6 Battery Connection, Numbering for 48 Volt Battery Pack

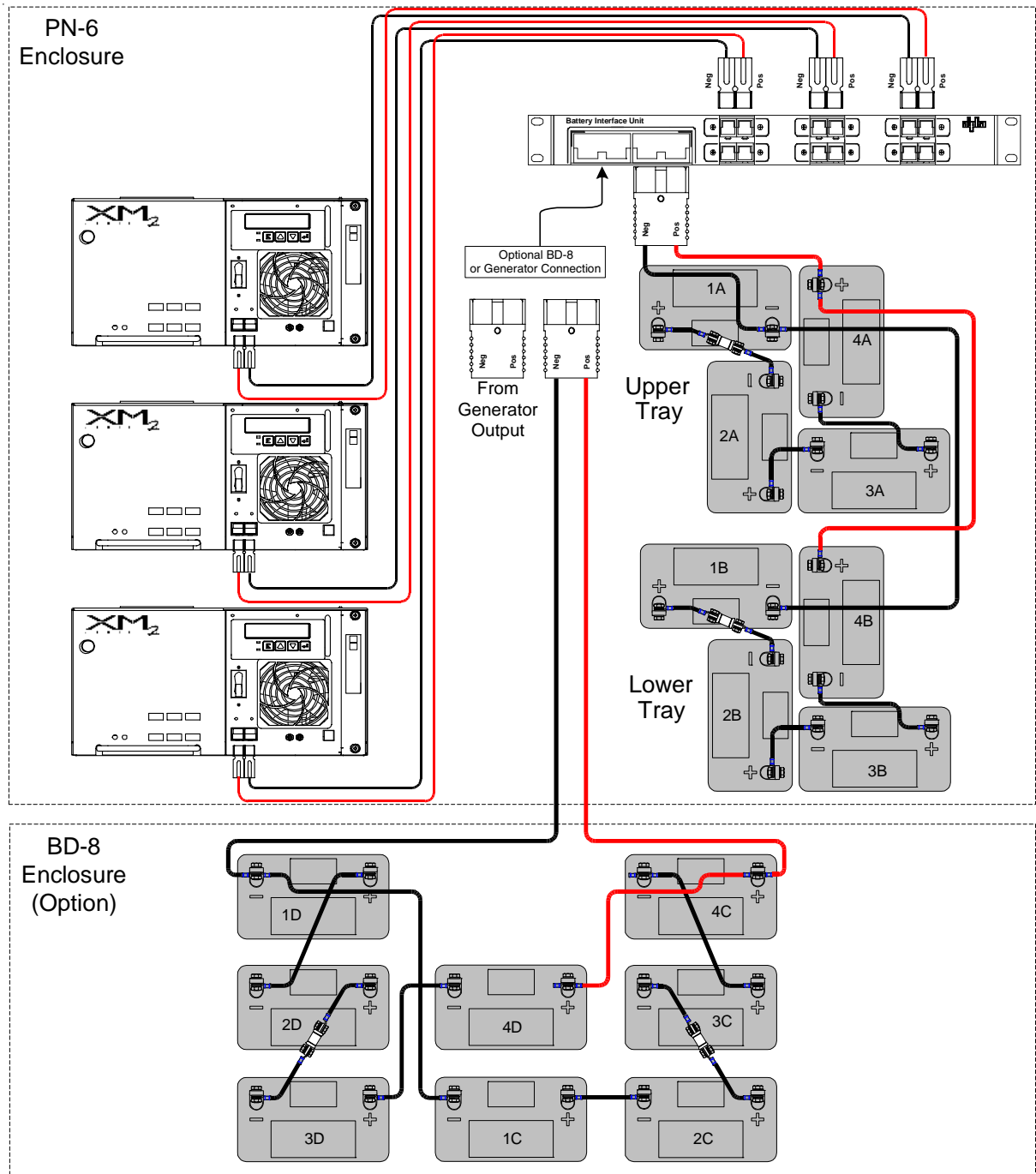

NOTE: Battery numbering scheme in accordance with SCTE guidelines for battery status monitoring.

Fig 3-11 Battery Power Distribution, 48 VDC

3.6 Battery Installation, *continued*

3.6.7 Battery Monitor Connection with optional Status Monitoring Module

The BATT connection (8-pin Mini Mate-n-Lok), on an optional Status Monitoring Module is an interface which enables the measuring of two sets of 36V or 48V battery strings. Refer to the status monitor's installation and operation manual for detailed instructions on wiring the battery packs.

3. Installation

3.7 Power Supply Installation

3.7.1 Power Supply Installation

Tools Needed:

None

Procedure:

1. Place an XMS2 power supply on one of the trays inside the enclosure.



2. Verify the input AC breaker is in the OFF position.

Plug the XMS2 into an available outlet on the left wall of the enclosure.



3.7 Power Supply Installation, *continued*

3.7.1 Power Supply Installation, *continued*

3. Verify that the Battery Circuit Breaker is in the OFF position. Connect the red and black battery cable to the BATTERY INPUT connection.

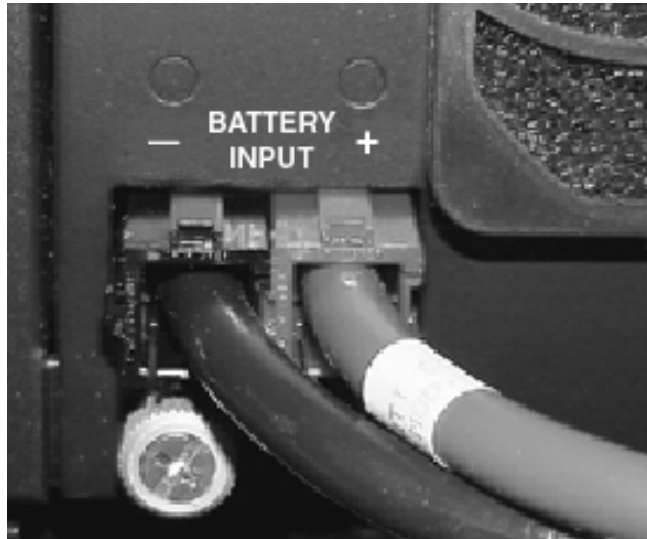

4. Connect the black and white wire from the SPI(s) to the OUTPUT connection on the front of the XMS2 power supply.

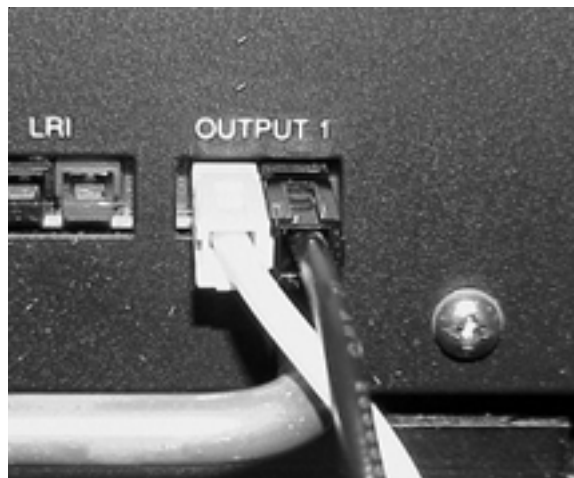

3. Installation

3.8 Battery Remote Temperature Sensor (RTS)

Tools Needed:

Adhesive Tape

Procedure:

1. Attach the RTS Probe to the inner side of one of the batteries with adhesive tape.
2. For enclosures with multiple battery strings, the RTS must be located with the WARMEST battery string. This ensures proper operation of the battery charger's temperature compensation circuit. Failure to locate the RTS with the warmest battery string could result in overcharging and premature battery failure.
3. The other side of the Temp Probe is attached to the front panel of the XMS2 power supply, in the jack labeled TEMP PROBE.

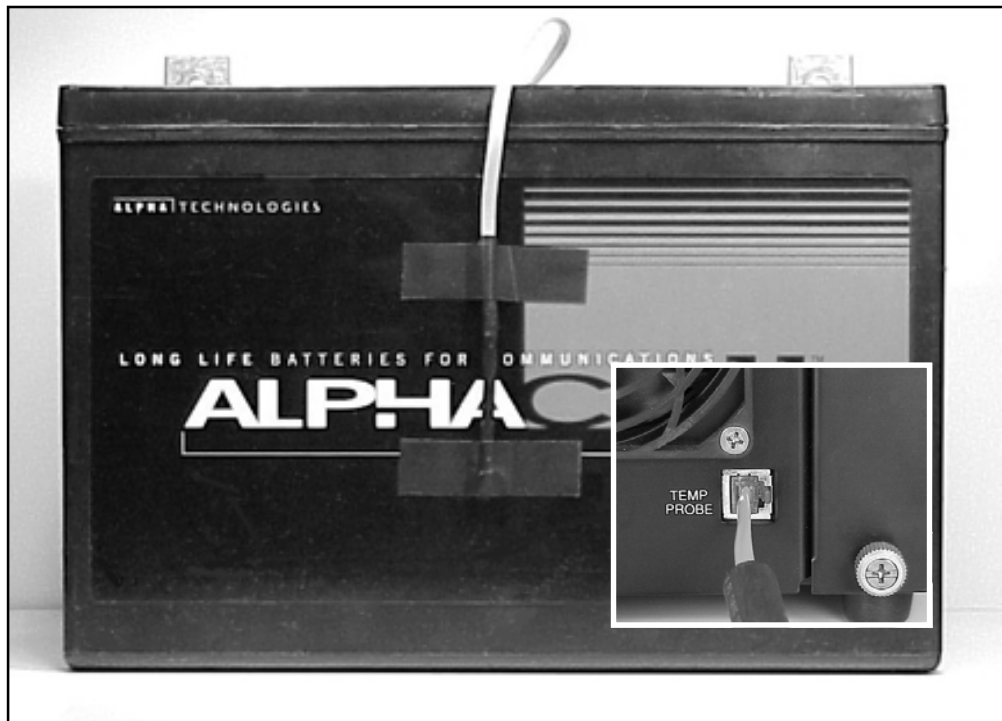

Fig 3-13 Battery Remote Temp Sensor (RTS) Placement

3.9 Lightning Arrester Option

Alpha's LA Series voltage suppressors provide reliable protection of power supplies and related equipment from the damaging powerline disturbances common to cable TV and broadband applications. The LA Series incorporates MOV's that effectively limit voltage surges and absorb excessive energy levels. Housed in a durable polymer casings with standard electrical plugs, the LA Series plugs directly into any electrical outlet.



NOTE: LED On - Operation Normal, LED Off - LAP has failed, Replace LAP

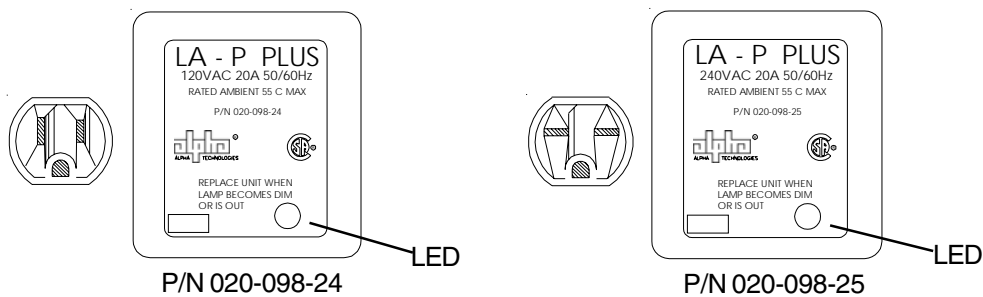

Fig. 3-14 LAP Plus

This hard-wired surge arrester is designed to protect against lightning induced surges for electrical equipment and wiring. When installed, the arrester will quickly divert to ground the lightning surges attempting to enter your electrical system. The surge protector is designed to handle repetitive operations. Excessive severe lightning can cause the device to fail, and it should be replaced under the following conditions: If any portion of the indicating window is black, or if the indicating window is completely black.

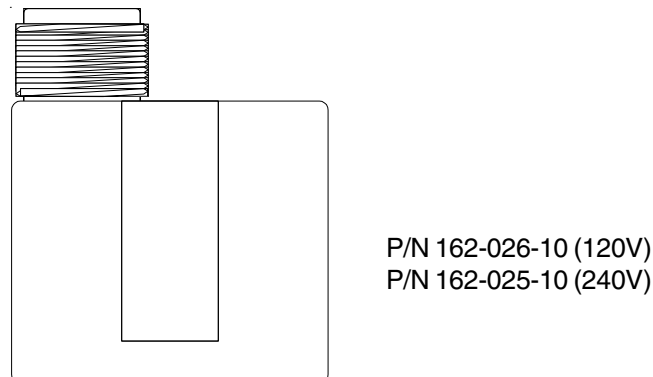

Fig. 3-15 Line Surge Arrester

3. Installation

3.10 Part Numbers for Optional Equipment

Item:	Part Number:
Star Lock Security Bolt (X4)	744-897-20
Security Key	647-089-10
Cooling Fan	
Replacement Fuse	460-192-10
Tamper Switch TS-CE6-NC	745-023-20
Tamper Switch TS-CE6-BD8-NC	745-023-21
Lightning Arrester	
LA-P+ 120V (L-N, L-G, N-G)	020-098-24
LA-PC+ 120V (L-N, L-G, N-G)	020-098-26
LA-PE+ 240V (L1-L2, L1-G, L2-G)	020-098-25
Extra SPI (20 Amp)	744-279-22
Extra SPI (25 Amp)	744-789-21
Extra SPI (25 Amp) 60" lead	744-789-25



NOTE:

Alpha part numbers are correct at the time of printing. As part numbers are subject to change, please contact your Alpha Representative prior to ordering to ensure that numbers are correct.

Power

Alpha Technologies 

Corporate
Alpha Technologies
3767 Alpha Way
Bellingham, WA 98226
USA
Tel: (360) 647-2360
Fax: (360) 671-4936
Web: www.alpha.com

Alpha Technologies Ltd.
4084 McConnell Court
Burnaby, BC, V5A 3N7
CANADA
Tel: (604) 430-1476
Fax: (604) 430-8908

Alpha Technologies
Europe Ltd.
Cartel Business Estate
Edinburgh Way
Harlow, Essex CM20 2TT
UNITED KINGDOM
Tel: +44-1279-422110
Fax: +44-1279-423355

Alpha Technologies
Hansastrasse 8
D-91126 Schwabach
GERMANY
Tel: +49-9122-79889-0
Fax: +49-9122-79889-21

Alphatec
339 St. Andrews Street
Suite 101
Andrea Chambers
Limassol, Cyprus
CYPRUS
Tel: +357-25-375675
Fax: +357-25-359595

Alpha Technologies
Unit R5-R7 Regents Park Estate
Corner Park Rd and Prince's Rd East
Regents Park, NSW 2143
AUSTRALIA
Tel: +61-2-9722-3320
Fax: +61-2-9722-3321