

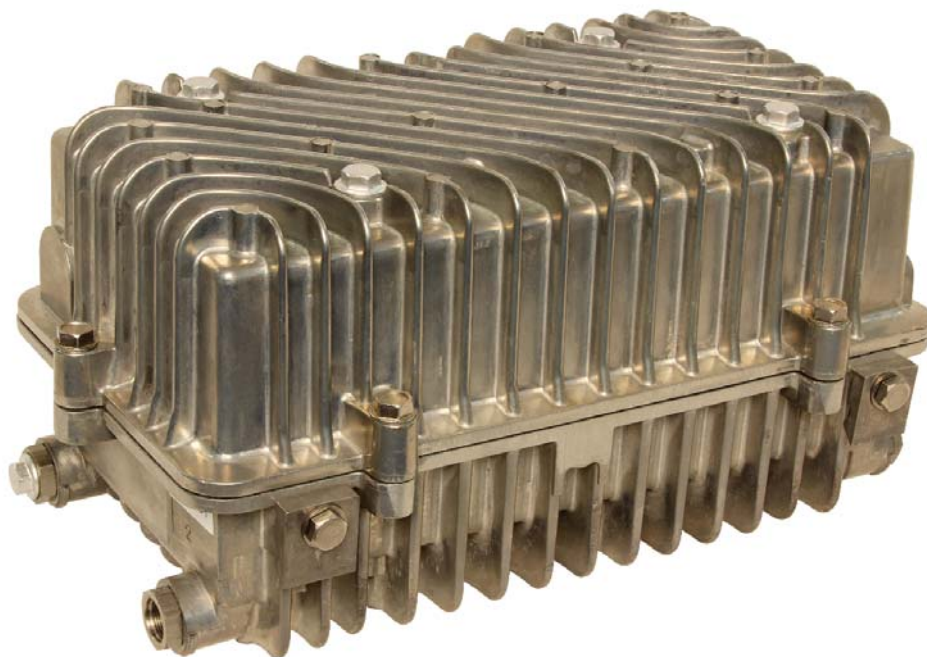

Alpha Power Booster

Technical Manual

APB HFC Voltage Booster
Effective: December 2011



Power Alpha Technologies 

Alpha Power Booster APB HFC Voltage Booster 016-559-B0-001, Rev. A

Effective Date: December, 2011

Copyright © 2011

Alpha Technologies, Inc.

member of The  Group™



NOTE:

Photographs contained in this manual are for illustrative purposes only. These photographs may not match your installation.



NOTE:

Operator is cautioned to review the drawings and illustrations contained in this manual before proceeding. If there are questions regarding the safe operation of this powering system, please contact Alpha Technologies or your nearest Alpha representative.



NOTE:

Alpha shall not be held liable for any damage or injury involving its enclosures, power supplies, generators, batteries, or other hardware if used or operated in any manner or subject to any condition not consistent with its intended purpose, or is installed or operated in an unapproved manner, or improperly maintained.

Contacting Alpha Technologies: *www.alpha.com*

or

For general product information and customer service (7 AM to 5 PM, Pacific Time), call

1-800-863-3930

For complete technical support, call

1-800-863-3364

7 AM to 5 PM, Pacific Time or 24/7 emergency support

Contents

Safety Notes	6
Safety Precautions	6
1.0 System Overview.....	7
1.1 Introduction	7
1.2 Internal Components.....	8
2.0 Installation.....	9
2.1 Enclosure Installation.....	9
2.1.1 Strand Mounting.....	9
2.1.2 Surface Mounting.....	10
2.2 Output Voltage Configuration.....	11
2.3 Cable Preparation	12
2.4 RF Module Removal	14
2.5 Coaxial Cable Attachment.....	15
2.6 RF Module Reinstallation.....	16
2.7 Power Up and Test.....	17
2.7.1 Initial Power Up.....	17
2.8 Final Assembly	18
2.9 Specifications.....	19
2.10 Troubleshooting	20
2.11 Voltage Booster Service.....	21
2.11.1 PCB Replacement Procedure	21
2.11.2 Transformer Replacement Procedure.....	22

Figures

Fig. 1-1, APB Voltage Booster	7
Fig. 1-2, APB Internal Components	8
Fig. 2-1, Label with Factory Config Field	11
Fig. 2-2, Configuration Connect.....	11
Fig. 2-3, Coaxial Cable Connector.....	12
Fig. 2-4, RF Module Removal.....	14
Fig. 2-5, RF Module Removed.....	14
Fig. 2-6, Seizure Connector.....	15
Fig. 2-7, Visible Center Conductor of Installed Connector.....	15
Fig. 2-8, RF Module Installation.....	16
Fig. 2-9, Cover Bolts	18

Tables

Table 2-1, Troubleshooting Guide	20
--	----

Safety Notes

Review the drawings and illustrations contained in this manual before proceeding. If there are any questions regarding the safe installation or operation of this product, contact Alpha Technologies or the nearest Alpha representative. Save this document for future reference.

To reduce the risk of injury or death, and to ensure the continued safe operation of this product, the following symbols have been placed throughout this manual. Where these symbols appear, use extra care and attention.

ATTENTION:

The use of ATTENTION indicates specific regulatory/code requirements that may affect the placement of equipment and/or installation procedures.

NOTE:

A NOTE provides additional information to help complete a specific task or procedure.

CAUTION!

The use of CAUTION indicates safety information intended to PREVENT DAMAGE to material or equipment.

WARNING!

WARNING presents safety information to PREVENT INJURY OR DEATH to the technician or user.

Safety Precautions

- Only qualified personnel may service the APB Voltage Booster.
- Verify the voltage requirements of the equipment to be protected (load), the AC input voltage to the voltage booster (line), and the output voltage of the system prior to installation.
- When connecting the load, DO NOT exceed the output rating of the voltage booster.
- Always use proper lifting techniques whenever handling units.
- Avoid using uninsulated tools or other conductive materials when working inside the enclosure.
- Remove all rings, watches and other jewelry before servicing voltage booster.

1.0 System Overview

1.1 Introduction

The Alpha Power Booster (APB) was created to improve network efficiency and reduce life cycle cost by eliminating lightly loaded power supplies at the end of long amplifier cascades. The voltage booster accomplishes this by boosting end-of-line voltages. The voltage boost allows deeper penetration of the HFC network and eliminates the need for power supplies and batteries near the end of the HFC network.

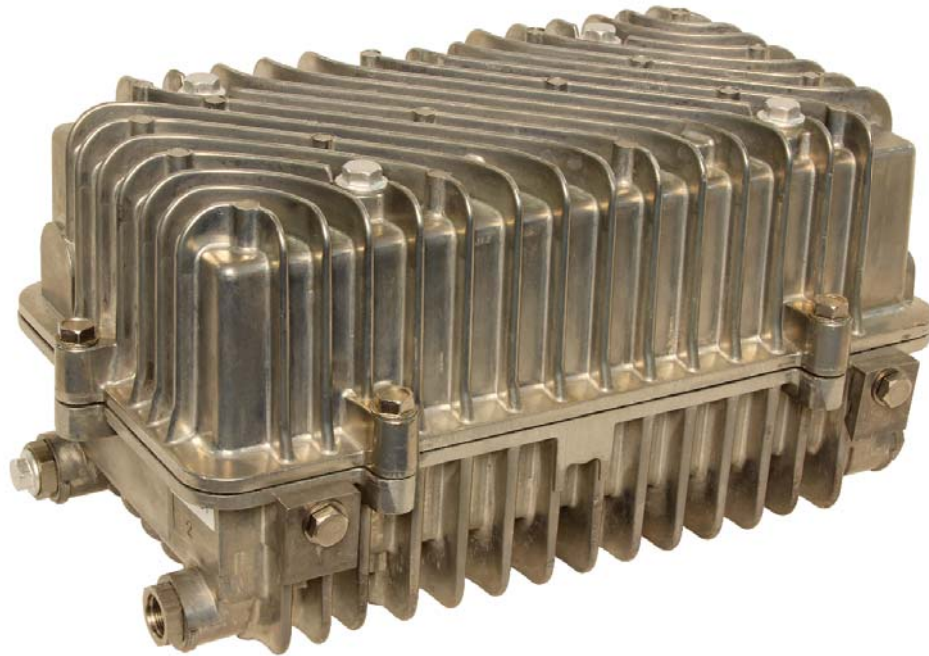

Fig. 1-1, APB Voltage Booster

1.0 System Overview, continued

1.2 Internal Components

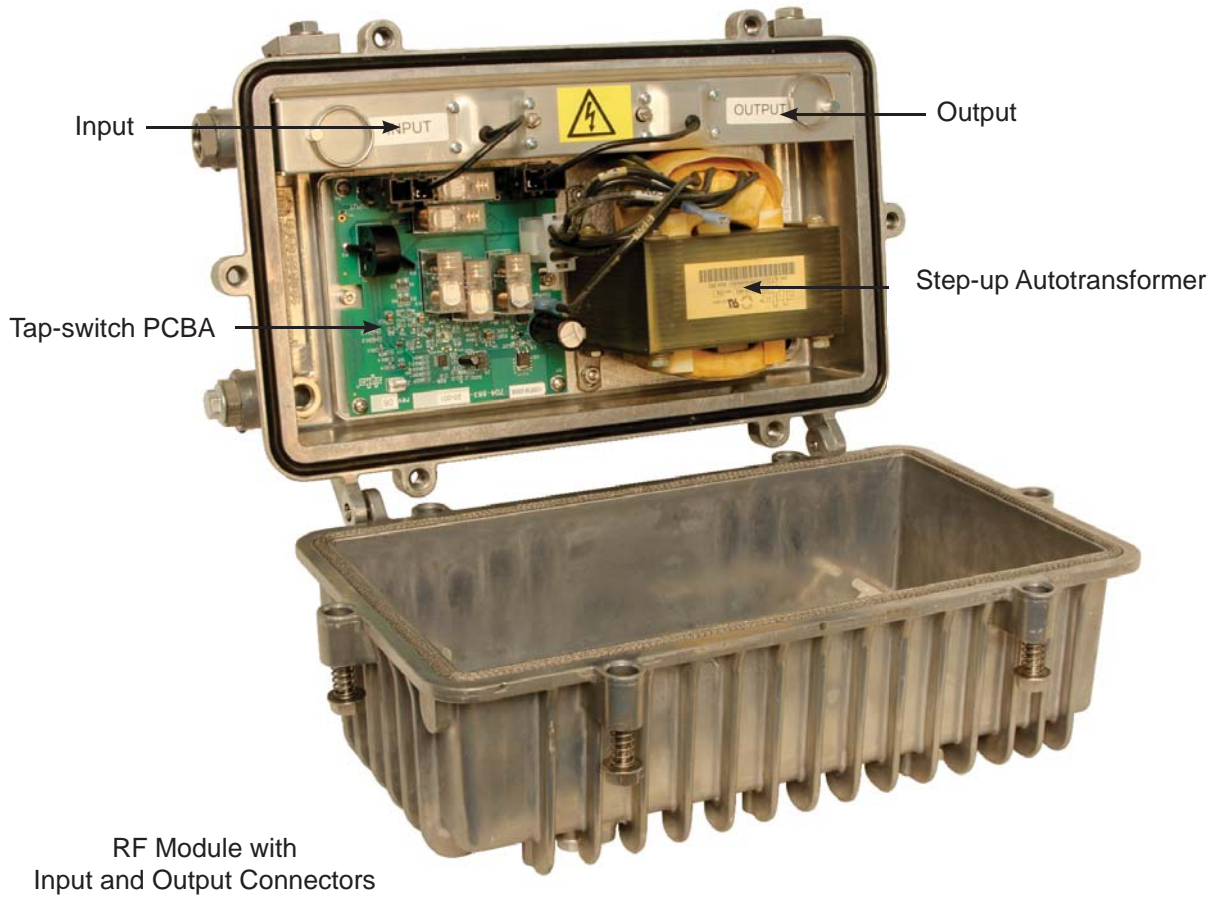

Fig. 1-2, APB Internal Components

2.0 Installation

2.1 Enclosure Installation

2.1.1 Strand Mounting

Tools Required:

- 1/2" Socket
- 0-100 in-lb torque wrench

Procedure:

1. Loosen the two strand clamps on the enclosure. Ensure that the side labeled "INPUT" is facing the correct direction.
2. Place the strand wire under the clamp plates and torque the bolts to 75 in-lbs.
3. Ensure that the output voltage is configured properly. Refer to section 2.2 if the output voltage requires changing.
4. Prepare the coaxial connector(s) as outlined in Section 2.3, "Cable Preparation". Install the connector(s) and tighten to proper torque supplied by the manufacturer.

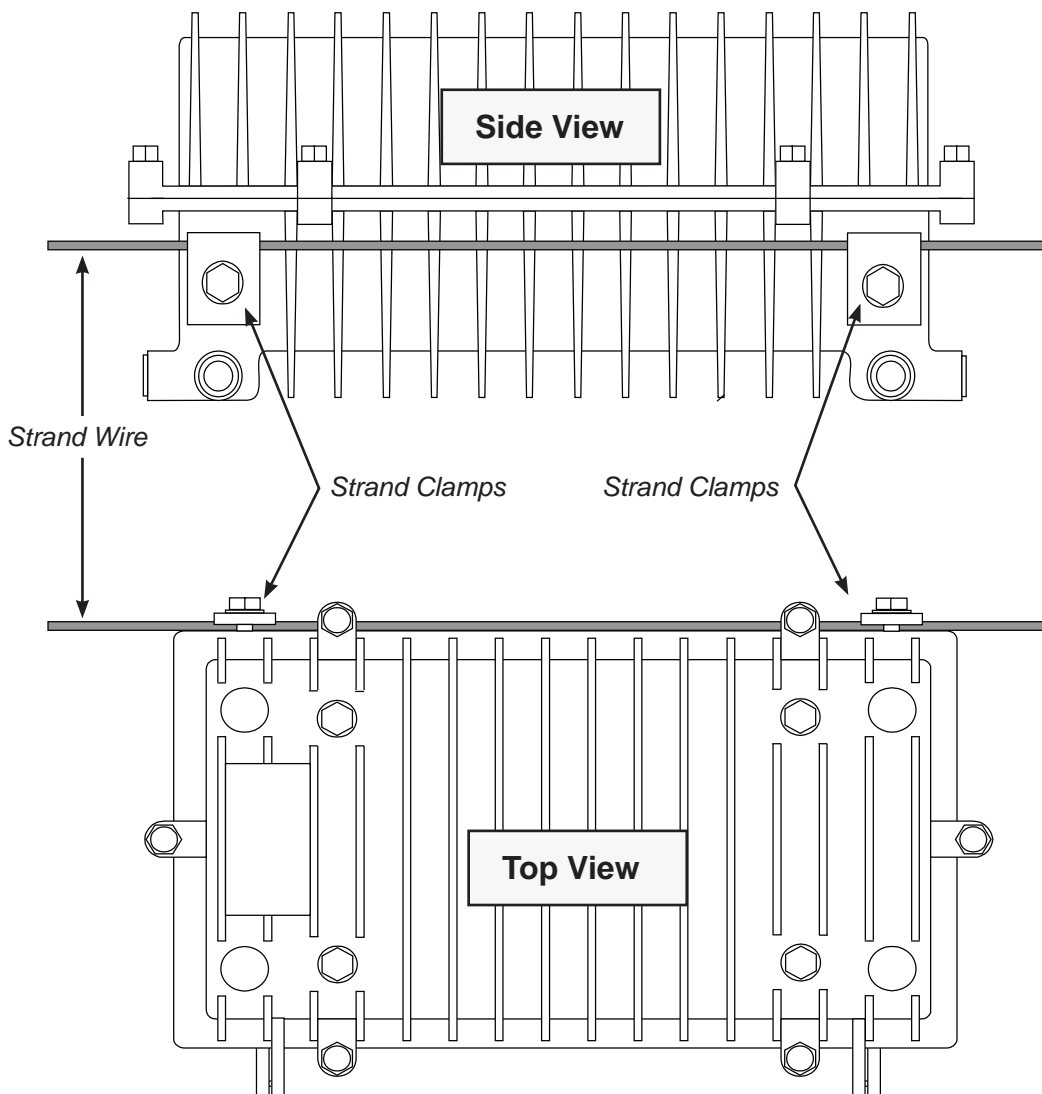

2.0 Installation, continued

2.1 Enclosure Installation, continued

2.1.2 Surface Mounting

Tools Required:

- 1/2" Socket
- 0-100 in-lb torque wrench
- Drill
- 3/8" drill bit

Procedure:

1. Loosen the two strand clamps on the enclosure. Ensure that the side labeled "INPUT" is facing the correct direction.
2. Verify that the mounting surface is flat between the mounting locations prior to drilling.
3. Drill two 3/8" holes that are 10" apart.
4. The threaded holes in the enclosure are 1/2" deep. Verify the bolts extend no more than 3/8" through the mounting surface. Use 5/16"-18 threaded bolts.
5. Tighten the mounting bolts to 90 in-lbs.
6. Tighten the coaxial connector(s) to proper torque provided by the manufacturer.

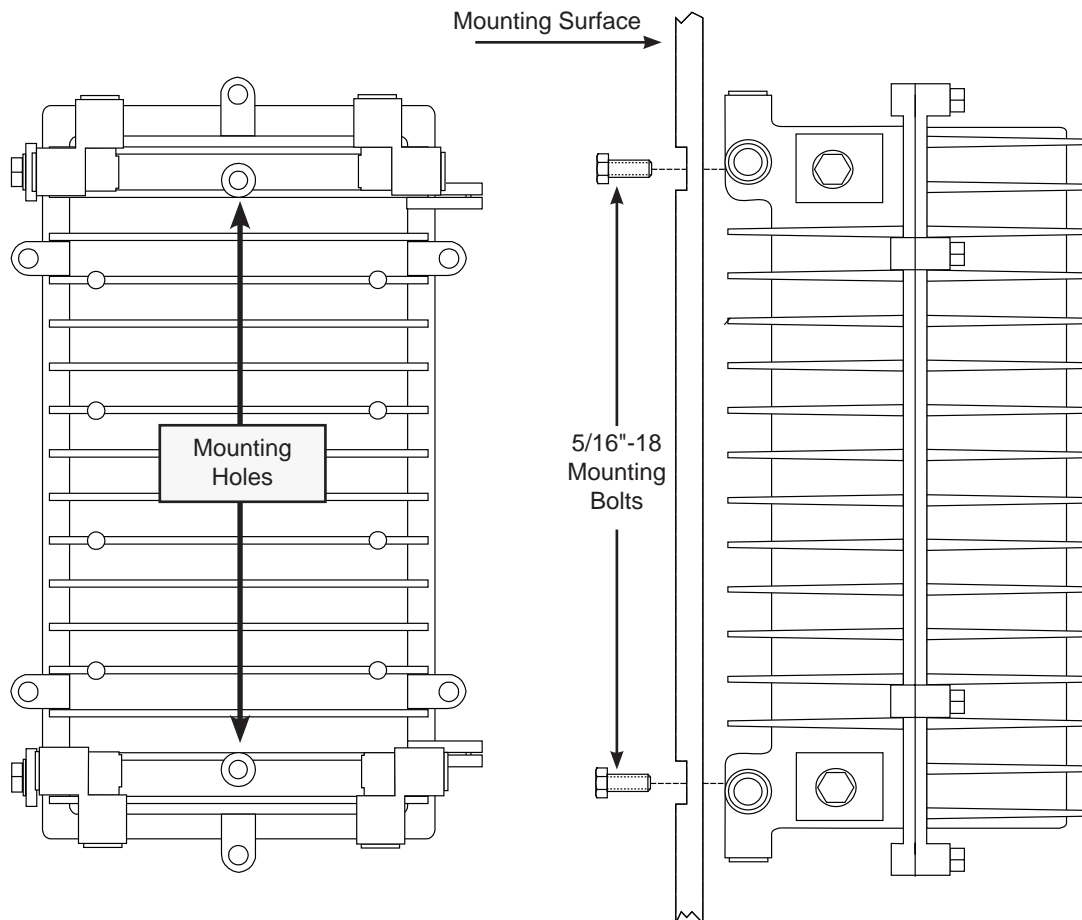

2.0 Installation, continued

2.2 Output Voltage Configuration

Tools Required:

- True RMS Volt Meter
- Clamp-On Amp Meter

1. Note the factory configured output voltage by reading the label on the side of the housing. The label has a field named FACTORY CONFIG that will be filled with either 63Vac or 87Vac.

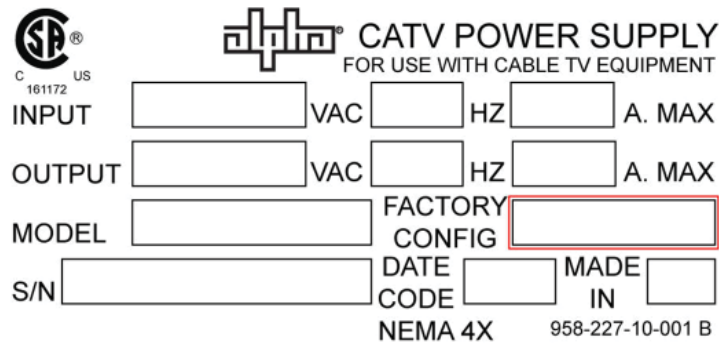

Fig. 2-1, Label with Factory Config Field

2. If the factory configuration must be changed, unplug the quick connects and attach the connector labelled LOG87 (for 90V plant) or LOG63 (for 60V plant) to the "Configuration" male quick connect. The unused wire should be attached to P4 to prevent arcing to the power supply housing.



Fig. 2-2, Configuration Connect

2.0 Installation, continued

2.3 Cable Preparation

Tools Required:

- Wire Cutters
- Open-End wrenches (refer to manufacturer's assembly instructions)



WARNING!

Coaxial cables may carry AC power. To avoid possible shock or damage to the equipment, always handle coaxial cables with extreme caution. Always install coaxial connectors with the RF module removed from the enclosure.



NOTE:

This section is for reference only; follow instructions provided by the connector's manufacturer.

Procedure:

1. Assemble coaxial connectors with no more than 13 inches between ends.
2. Cut the pin length as shown on the following page.

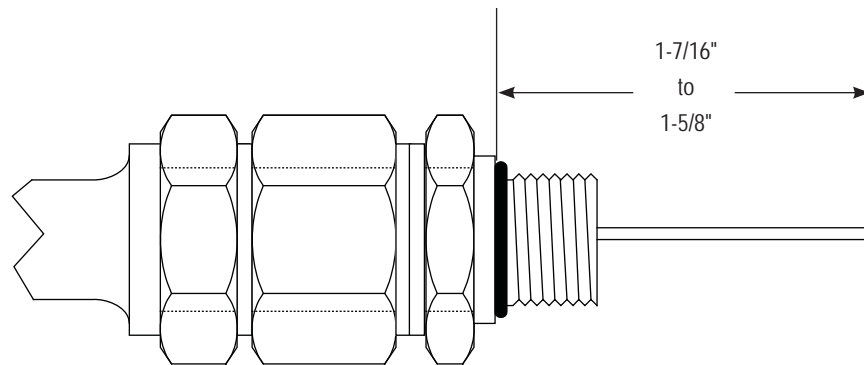

Fig. 2-3, Coaxial Cable Connector

2.0 Installation, continued

2.3 Cable Preparation, continued

Installation is complete. Go to Power Up and Test (Section 2.7, Power Up and Test).

3. Locate the measuring gauge near port number 1 or 2.

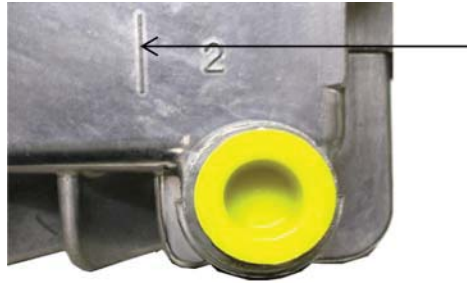

4. Place the connector's collar against the edge of the measuring gauge molded into the enclosure.



5. Using heavy duty wire cutters, clip the pin as close to the line as possible.



2.0 Installation, continued

2.4 RF Module Removal

Tools Required:

- No. 2 Flat head screwdriver

Procedure:

1. Disconnect the two Molex connectors (Output, J4, Input, J5).
2. Loosen the two captive screws near the center of the module.
3. Grasp the pull rings with your index fingers and pull firmly away from the enclosure.

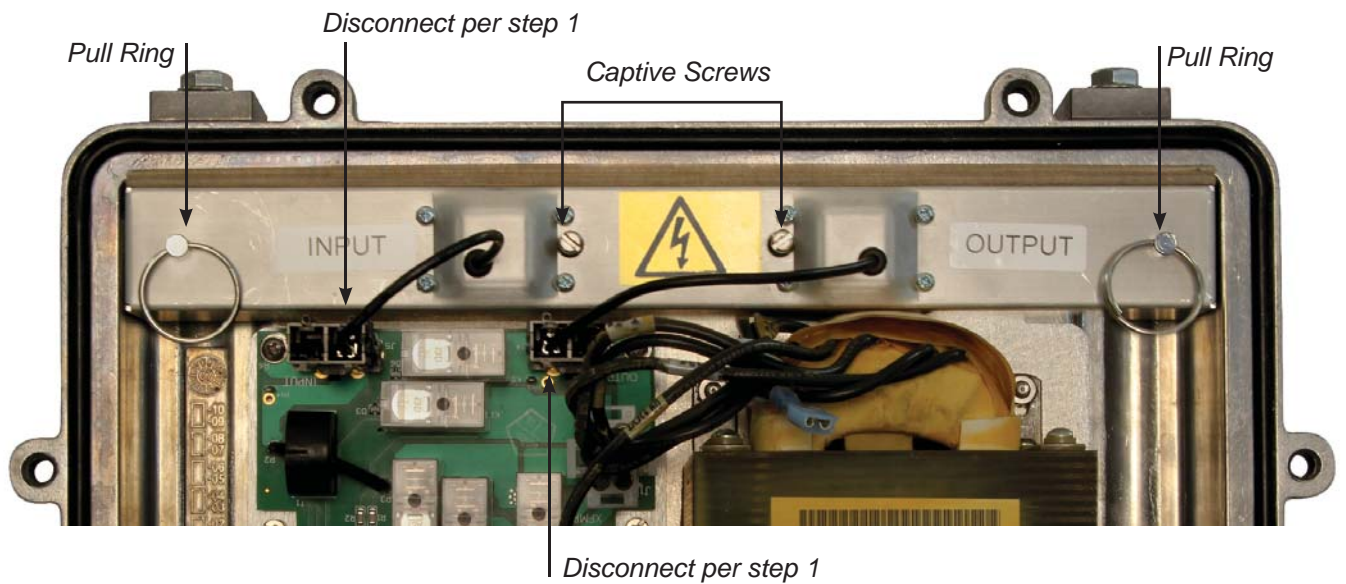

Fig. 2-4, RF Module Removal



Fig. 2-5, RF Module Removed

2.0 Installation, continued

2.5 Coaxial Cable Attachment

Tools Required:

- 5/8" socket wrench with 6" extension
- 20-200 in-lb torque wrench

Procedure:

1. Remove the two seizure connectors from the enclosure.



Fig. 2-6, Seizure Connector



NOTE:

Verify center conductor is centered in the groove in the plastic base.

2. Insert the prepared coaxial connector into the desired port (1-input; 2-output) and torque to 180 in-lbs.
3. Replace the seizure connectors and torque to 90 in-lbs.



Fig. 2-7, Visible Center Conductor of Installed Connector

2.0 Installation, continued

2.6 RF Module Reinstallation

Tools Required:

- No. 2. Flat head screwdriver
- Torque screwdriver

Procedure:

1. Firmly seat the module over the seizure connectors, with the open side facing AWAY from the circuit board.
2. Tighten the captive screws to 18 in-lbs.

WARNING!

The enclosure may become electrified if mis-wired or in the event of an internal short. Measure the voltage between the enclosure and earth ground before touching with bare hands.

3. Connect the Molex connectors (Output, J4, Input, J5). Ensure that the output connector is plugged into J4 and the input connector is plugged into J5.

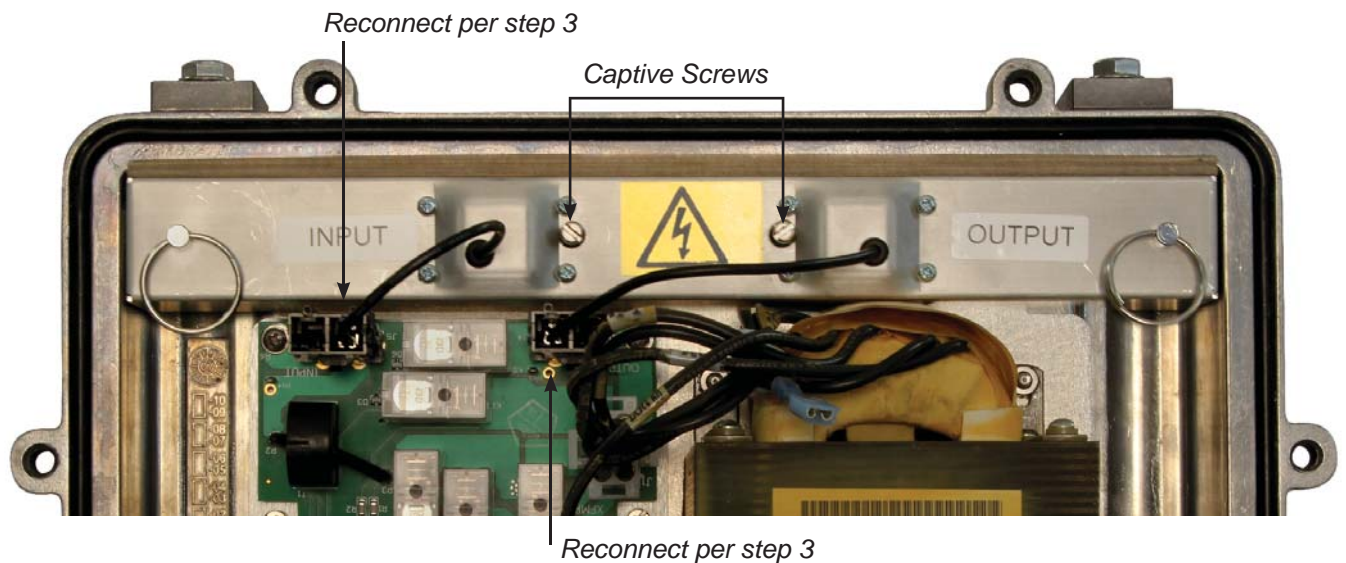

Fig. 2-8, RF Module Installation

2.0 Installation, continued

2.7 Power Up and Test

2.7.1 Initial Power Up

Tools Required:

- True RMS Volt Meter
- Clamp-On Amp Meter

WARNING!

There will be up to 90Vac present on the PCB when a live connector is plugged into the input or output connectors.

Procedure:

1. Plug the Output Connector from the RF Module into the J4 Output Connector (**item 1**) of the PCB.
2. Plug the Input Connector from the RF Module into the J5 Input Connector (**item 2**) of the PCB. Verify the GREEN LED (**item 3**) on PCB is lit.
3. Using the volt meter, measure the output voltage between TP13 and the enclosure chassis. The voltage should be approximately 87Vac for the 87Vac configuration or 63Vac for the 63Vac configuration.
4. Place a Clamp-on amp meter over the output wire coming from the Output connector J4 on the PCB and the RF Module. The current must be less than 8A RMS. If the current exceeds 8A RMS, resolve the cause of the short-circuit or overload condition.

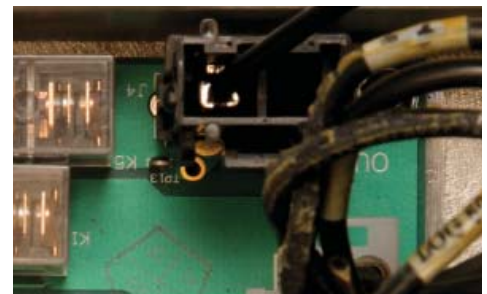
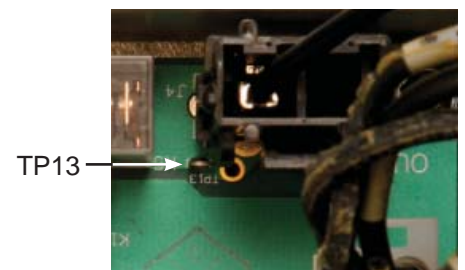
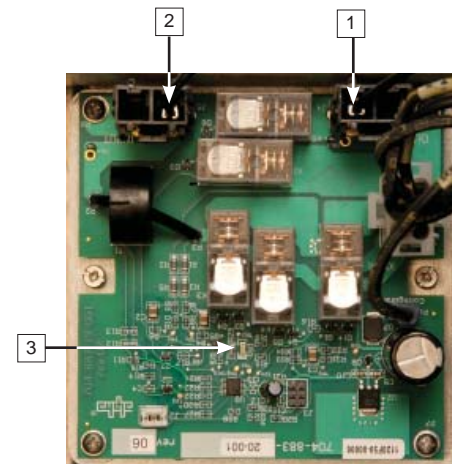

2.0 Installation, continued

2.8 Final Assembly

Tools Required:

- 1/2" Socket
- 0-100 in-lb torque wrench

Procedure:

1. Close the cover of the enclosure, making sure no wires are being pinched. Tighten all bolts finger tight.
2. Tighten the enclosure cover bolts to 30 in-lbs, in the sequence shown. Repeat the procedure, tightening the bolts to 70 in-lbs.

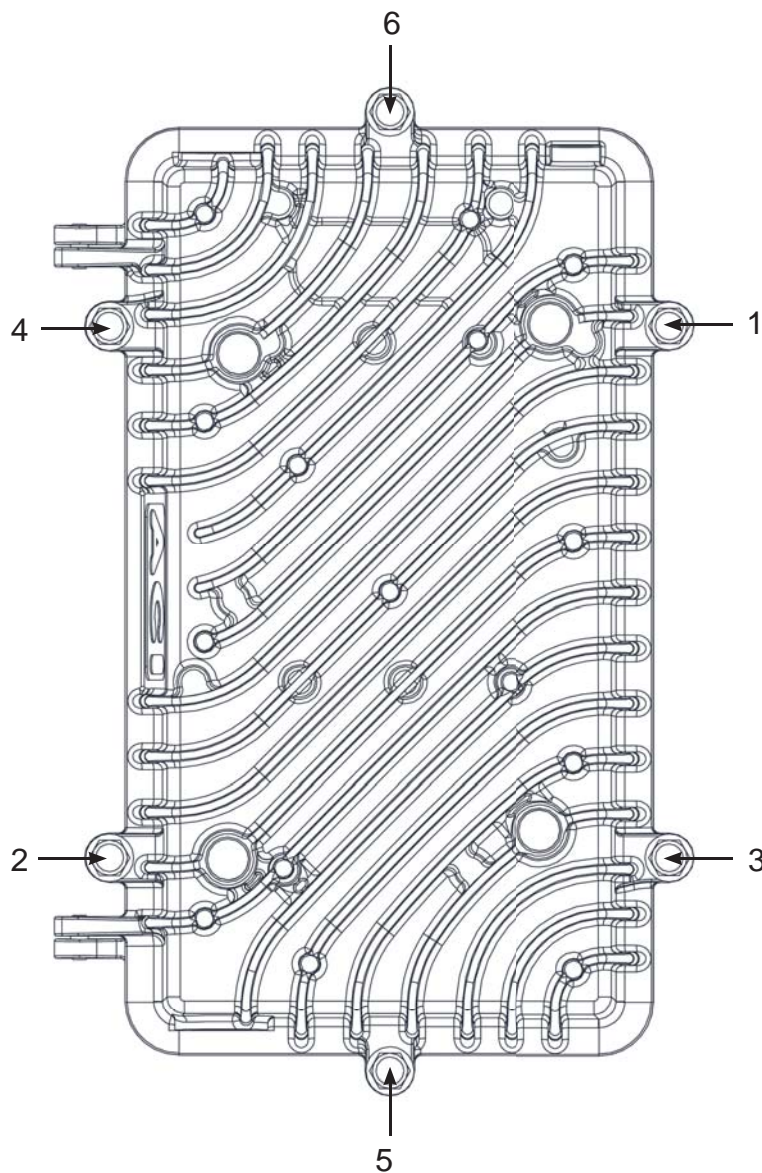

Fig. 2-9, Cover Bolts

2.0 Installation, continued

2.9 Specifications

Specifications	
Electrical	
Input Voltage	45-65Vac 60Hz / 65-90Vac 60 Hz
Input Current	10 Amps RMS (max)
Output Voltage	63Vac 60Hz / 87Vac 60Hz
Output Current	<8 Amps RMS (max)
Output Rating	650 VA (max)
Overload Protections	115% for 27 minutes
Short Circuit	Bypass mode, automatic recovery
Overload Recovery	Automatic
Surge Resistance	6kV/3000A (IEEE C61.45 part 15)
Efficiency	>96% at 25 to 100 percent load
RF Freq Range	5MHz to 1000MHz
RF Insertion Loss Maximum	1.2 dB (5MHz to 50MHz) 1.2 dB (50MHz to 870MHz) 1.6 dB (870MHz to 1000MHz)
Flatness	±0.25 dB (5MHz to 50MHz) ±0.35 dB (50MHz to 870MHz) ±0.50 dB (870MHz to 1000MHz)
RF Slope Maximum	0.80dB (5MHz to 50MHz) -1.0dB (50MHz to 870MHz), -1.25dB (870MHz to 1000MHz)
Hum Modulation	< -68 dB (5MHz to 1000MHz)(< -82 dB freq. domain)
Return Loss Minimum	17 dB (5MHz to 1000MHz)
Electrical Egress	<-120dBm (45MHz to 870MHz)
Isolation	Neutral carries through
Environmental	
Operating Temperature	-40°F to 149°F (-40°C to 65°C)
Storage Temperature	-58°F to 158°F (-50°C to 70°C)
Outdoor Rating	Type 4 Enclosure
Standard Compliance	
Safety	CSA (C/US) CAN/CSA C22.2 No. 60950-1-07 UL 60950-1, 2nd Edition
Standard Features	
High-efficiency autotransformer	
Intelligent overload protection	
Water-tight enclosure; wall or strand mounted	

2.0 Installation, continued

2.10 Troubleshooting

Troubleshooting Guide	
Symptom	Probable Cause and Solution
No Output	<p>No Input Voltage</p> <p>63Vac Config: Verify that no less than 45Vac is present on the input connector.</p> <p>87Vac Config: Verify that no less than 65Vac is present on the input connector.</p> <p>RF Module Not Fully Seated</p> <p>Ensure the RF Module is fully seated and the captive screws are tight. Module should be flush with the rim of the lower half of the enclosure. Check connections from RF Module to power supply.</p> <p>PCBA Connectors Not Fully Seated</p> <p>Ensure the RF Module connectors are fully seated to the PCBA at J4 & J5, and that the transformer connector is fully seated at J1.</p> <p>Overload Relay Open</p> <p>If the unit is overloaded it will open a relay to protect vital components and cease output. A solid green LED will light up on the PCBA if the unit is functional, but overloaded. In this situation the unit must be repositioned in the network where the input current is less than 10A.</p>
Output Voltage Low	<p>Input Voltage Below 45/65Vac</p> <p>Inspect input connections and upstream power supplies, verify no less than 45Vac (63Vac Config) or 65Vac (87Vac Config) is present at the input port (measure voltage from TP14 to the enclosure).</p> <p>Input and Output Coax Connectors Reversed</p> <p>Verify the Coax Input Connector is connected to Port 1.</p>
Output Voltage High	<p>Input Voltage Above 63/90Vac</p> <p>Inspect input connections and upstream power supplies, verify no greater than 63Vac (63Vac Config) or 90Vac (87Vac Config) is present at the input port (measure voltage from TP14 to the enclosure).</p>

Table 2-1, Troubleshooting Guide

2.0 Installation, continued

2.11 Voltage Booster Service

Tools Required:

- No. 2 Phillips head screwdriver



WARNING!

There will be up to 90Vac present on the PCB when a live connector is plugged into the input or output connectors.

2.11.1 PCB Replacement Procedure

1. Unplug Input Connector from J5 of the PCB.
2. Unplug Output Connector from J4 of the PCB.
3. Unplug XFMR Connector from J1 of the PCB.
4. Loosen captive bracket screws at "4" (2 places).
5. Remove assembly.
6. Install new assembly and tighten the captive bracket screws at "4" (2 places).
7. Plug XFMR Connector into J1 of the PCB.
8. Plug Output Connector into J4 of the PCB.
9. Plug Input Connector into J5 of the PCB.
10. Perform power up test (section 2.7.1), and final assembly (section 2.8).

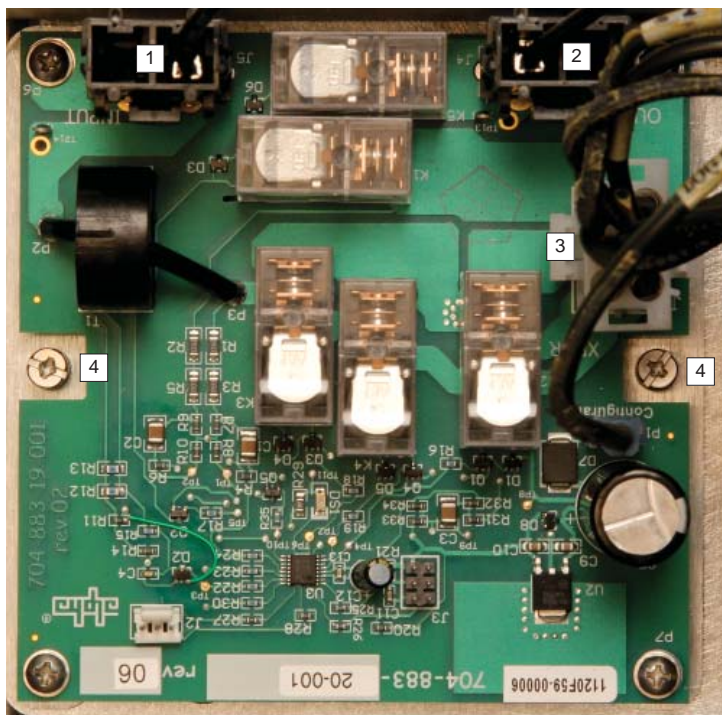

2.0 Installation, continued

2.11 Voltage Booster Service, continued

Tools Required:

- 11/32 Nutdriver

WARNING!

There will be up to 90Vac present on the PCB when a live connector is plugged into the input or output connectors.

2.11.2 Transformer Replacement Procedure

1. Unplug transformer connector from J1 of the PCB.
2. Unplug transformer quick connects from Configuration (P1) and P4 of the PCB. Note which connector is attached to the Configuration male connector (LOG63 or LOG87).
3. Remove nuts at "3" (4 places).
4. Remove transformer.
5. Install new transformer with nuts at "3" (4 places).
6. Plug the connector from step 2 into the Configuration male connector (P1). Plug the other unused connector into P4.
7. Plug the transformer connector into J1 of the PCB.



this page intentionally blank

**Alpha Technologies Inc.**

3767 Alpha Way
Bellingham, WA 98226
United States
Tel: +1 360 647 2360
Fax: +1 360 671 4936

Alpha Energy

1628 W Williams Drive
Phoenix, AZ 85027
United States
Tel: +1 623 251 3000
Fax: +1 623 249 7833

Alpha Technologies Europe Ltd.

Twyford House Thorley
Bishop's Stortford
Hertfordshire, CM22 7PA
United Kingdom
Tel: +44 1279 501110
Fax: +44 1279 659870

Alpha Technologies

Unit 504, 5/F,
Fourseas Building
No 208-212 Nathan Road
Kowloon, Hong Kong
Tel: +852 2736 8663
Fax: +852 2199 7988

Alpha Technologies Ltd.

7700 Riverfront Gate
Burnaby, BC V5J 5M4
Canada
Tel: +1 604 436 5900
Fax: +1 604 436 1233
Toll Free: +1 800 667 8743

Alpha Technologies GmbH

Hansastraße 8
D-91126
Schwabach, Germany
Tel: +49 9122 79889 0
Fax: +49 9122 79889 21

Alphatec Ltd.

339 St. Andrews St.
Suite 101 Andrea Chambers
P.O. Box 56468
3307 Limassol, Cyprus
Tel: +357 25 375 675
Fax: +357 25 359 595

Alpha Innovations Brasil

Avenida Ibirapuera,
2120 – Cj 76
Moema - 04028-001
Santos SP, Brazil
Tel: +55 11 2476 0150
Fax: +55 11 2476 0150

Alpha Industrial Power Inc.

1075 Satellite Blvd NW,
Suite 400
Suwanee, GA 30024
United States
Tel: +1 678 475 3995
Fax: +1 678 584 9259

Technologies Argus

First de Mexico
Anatole France Num. 17
Colonia Polanco
11560, México D.F.
Tel: +52 55 5280 6990

Alpha TEK ooo

Khokhlovskiy Pereulok 16
Stroenie 1, Office 403
Moscow, 109028
Russia
Tel: +7 495 916 1854
Fax: +7 495 916 1349

Alphatec Baltic

S. Konarskio Street 49-201
Vilnius, LT-03123
Lithuania
Tel: +370 5 210 5291
Fax: +370 5 210 5292

Visit us at www.alpha.com

Power